

2-1445057-3 ✓ ACTIVE

MATE-N-LOK | Micro MATE-N-LOK

TE Internal #: 2-1445057-3

Micro MATE-N-LOK, Rectangular Power Connectors, Header, Plug, Wire-to-Board, 3 Position, 3mm [.118in] Centerline, Printed Circuit Board, UL 94V-0

[View on TE.com >](#)



Connectors > Power Connectors > Rectangular Power > Rectangular Power Connectors

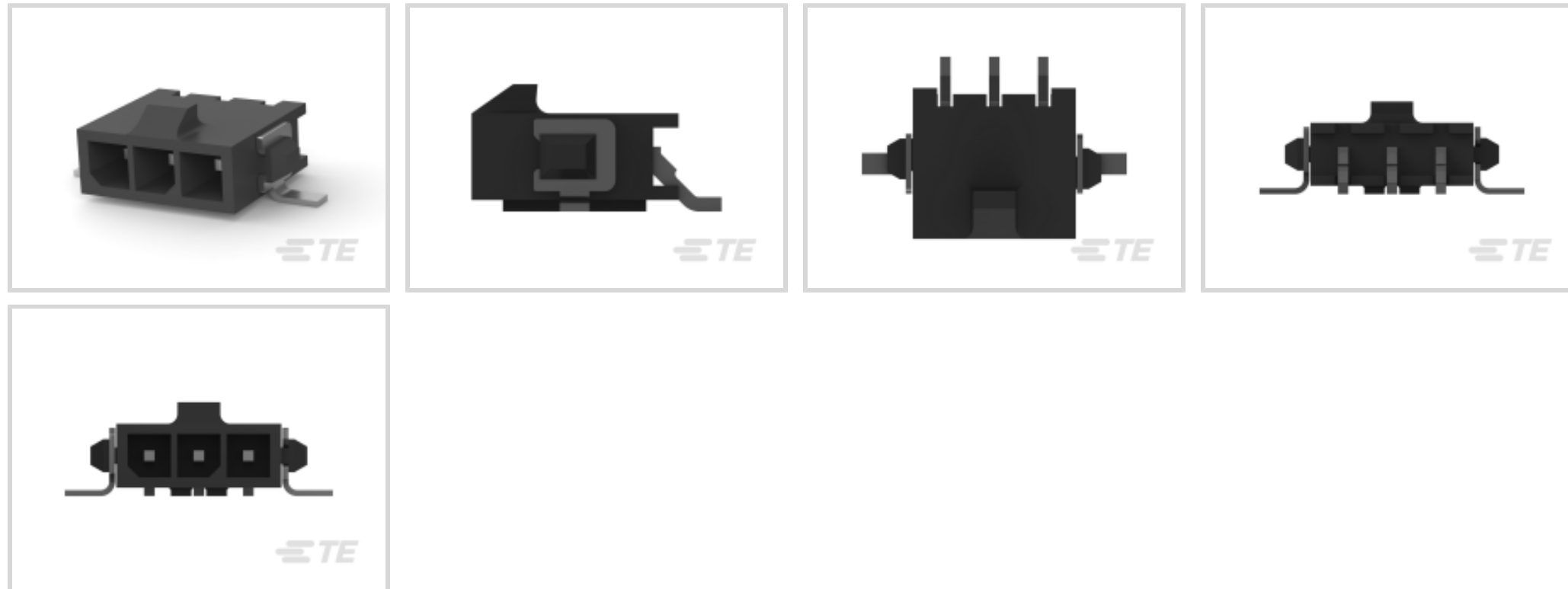

Rectangular Power Connector Type: **Header**

Connector & Housing Type: **Plug**

Connector System: **Wire-to-Board**

Number of Positions: **3**

Centerline (Pitch): **3 mm [.118 in]**

Features

Product Type Features

Rectangular Power Connector Type	Header
Connector & Housing Type	Plug
Connector System	Wire-to-Board
Sealable	No
Connector & Contact Terminates To	Printed Circuit Board

Configuration Features

Number of Positions	3
PCB Mount Orientation	Right Angle
Number of Power Positions	3
Number of Rows	1

Electrical Characteristics

Operating Voltage	250 VDC
-------------------	---------

Contact Features

Contact Layout	Inline
----------------	--------



Multiple Contact Types	Without
Contact Current Rating (Max)	5 A
Contact Retention Within Housing	Without
Contact Type	Pin
PCB Contact Termination Area Plating Material	Tin
Contact Mating Area Plating Material	Tin
Contact Mating Area Plating Material Thickness	2.54 μ m[100 μ in]
Contact Termination Area Plating Thickness	2.54 μ m[100 μ in]

Termination Features

Termination Post & Tail Length	1.4 mm[.055 in]
Termination Method to Printed Circuit Board	Surface Mount

Mechanical Attachment

Strain Relief	Without
Mating Alignment Type	Polarization
Mating Alignment	With
Panel Mount Feature	Without
PCB Mount Retention	With
PCB Mount Retention Type	Hold-Down Post
Connector Mounting Type	Board Mount
Mating Retention	With
Mating Retention Type	Locking Tab

Housing Features

Centerline (Pitch)	3 mm[.118 in]
Housing Color	Black
Housing Material	High Temperature Nylon
Boardlock Material	Phosphor Bronze

Dimensions

Insulation Diameter (Max)	1.52 mm[1.52 in]
Wire Size	.204 – .517 mm ²
PCB Thickness (Recommended)	.06 mm[1.57 in]

Usage Conditions

Operating Temperature Range	-40 – 105 °C[-40 – 221 °F]
-----------------------------	----------------------------



Operation/Application

Circuit Application	Power
---------------------	-------

Industry Standards

CSA Rating	Certified
UL Flammability Rating	UL 94V-0
Glow Wire Rating	Standard Part - Not Glow Wire
Agency/Standard Number	E28476
Agency/Standard	CSA, UL
UL Rating	Recognized
CSA File Number	LR7189
VDE Tested	Yes

Packaging Features

Packaging Method	Tape
Packaging Quantity	215

Other

For Use With	Receptacle Housing
--------------	--------------------

Product Compliance

[For compliance documentation, visit the product page on TE.com>](#)

EU RoHS Directive 2011/65/EU	Compliant
EU ELV Directive 2000/53/EC	Compliant
China RoHS 2 Directive MIIT Order No 32, 2016	No Restricted Materials Above Threshold
EU REACH Regulation (EC) No. 1907/2006	Current ECHA Candidate List: JAN 2021 (211) Candidate List Declared Against: JAN 2021 (211) Does not contain REACH SVHC
Halogen Content	Low Halogen - Br, Cl, F, I < 900 ppm per homogenous material. Also BFR/CFR/PVC Free
Solder Process Capability	Reflow solder capable to 260°C

Product Compliance Disclaimer

This information is provided based on reasonable inquiry of our suppliers and represents our current actual knowledge based on the information they provided. This information is subject to change. The part numbers that TE has identified as EU RoHS compliant have a maximum concentration of 0.1% by weight in homogenous materials for lead, hexavalent chromium, mercury, PBB, PBDE, DBP, BBP, DEHP, DIBP, and 0.01% for cadmium, or qualify for an exemption to these

limits as defined in the Annexes of Directive 2011/65/EU (RoHS2). Finished electrical and electronic equipment products will be CE marked as required by Directive 2011/65/EU. Components may not be CE marked. Additionally, the part numbers that TE has identified as EU ELV compliant have a maximum concentration of 0.1% by weight in homogenous materials for lead, hexavalent chromium, and mercury, and 0.01% for cadmium, or qualify for an exemption to these limits as defined in the Annexes of Directive 2000/53/EC (ELV). Regarding the REACH Regulation, the information TE provides on SVHC in articles for this part number is based on the latest European Chemicals Agency (ECHA) 'Guidance on requirements for substances in articles' posted at this URL: <https://echa.europa.eu/guidance-documents/guidance-on-reach>

Compatible Parts



Also in the Series | Micro MATE-N-LOK

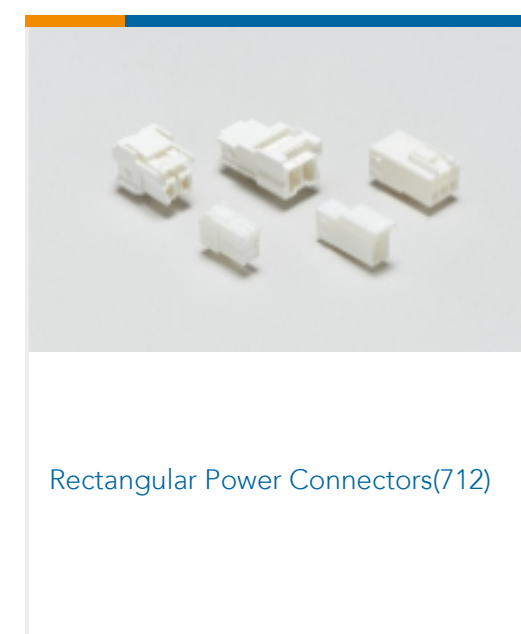
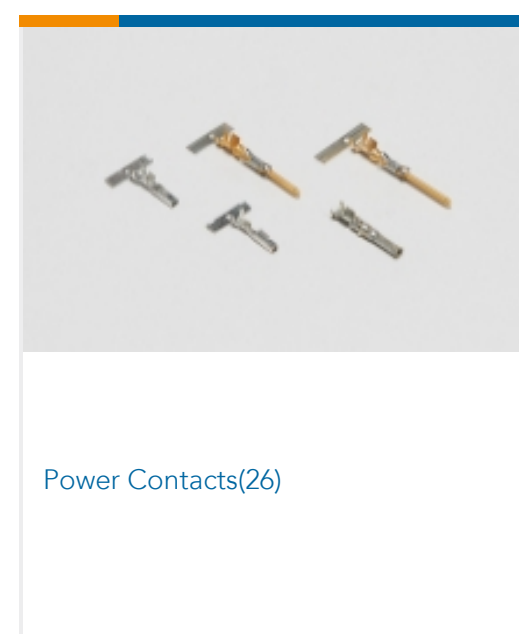
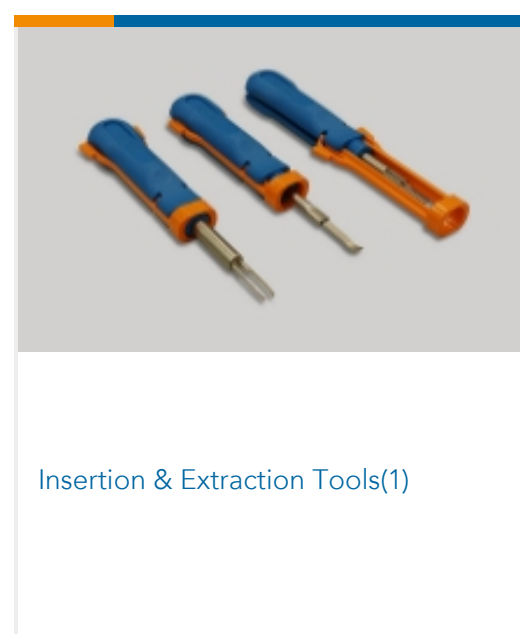
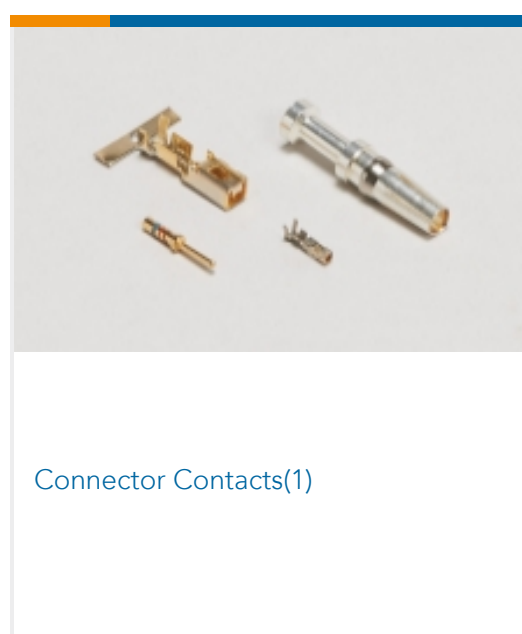

Customers Also Bought

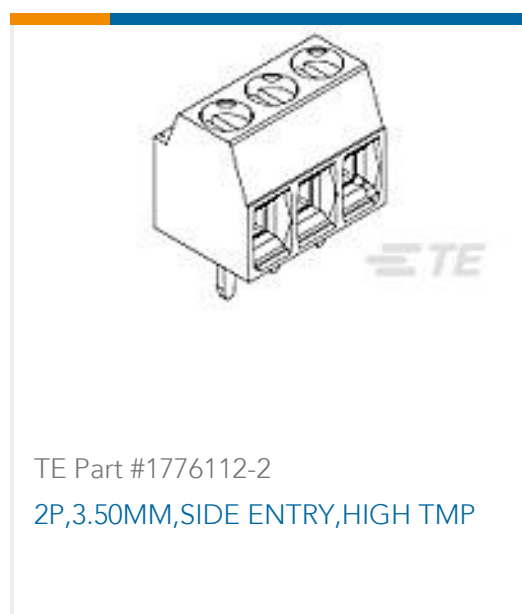
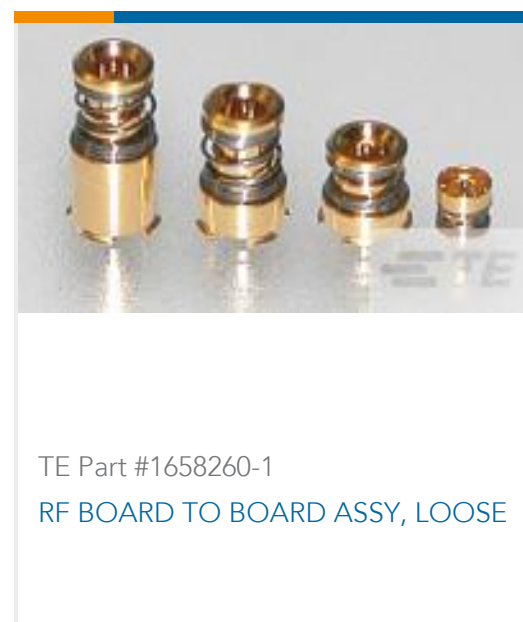

Documents

CAD Files

3D PDF

3D

Customer View Model

[ENG_CVM_CVM_2-1445057-3_D.2d_dxf.zip](#)

English

Customer View Model

[ENG_CVM_CVM_2-1445057-3_D.3d_igs.zip](#)

English

Customer View Model

[ENG_CVM_CVM_2-1445057-3_D.3d_stp.zip](#)

English

By downloading the CAD file I accept and agree to the [Terms and Conditions](#) of use.

Datasheets & Catalog Pages

[SOFT_SHELL_PIN_AND_SOCKET_CONNECTORS_CATALOG](#)

English

[1773458-4_MICRO_MATE_N_LOK_CONNECTOR_SYSTEM_QRG](#)



English

Product Specifications

Application Specification

English

Product Environmental Compliance

TE Material Declaration

English

Agency Approvals

UL

English