



SURFACE MOUNT Bias Tee

RCBT-63H+

50Ω Wideband 900 MHz to 6 GHz

THE BIG DEAL

- Low insertion loss, 0.3 dB typ.
- 2.5A DC current
- Good isolation, 20 dB typ.
- Good return loss, 18 dB typ.
- Miniature surface mount 0.31"x0.25"
- Aqueous washable

APPLICATIONS

- Biasing amplifiers
- Biasing of laser diodes
- Biasing of active antennas



Generic photo used for illustration purposes only

CASE STYLE: TT1224-2

+RoHS Compliant

The +Suffix identifies RoHS Compliance.
See our website for methodologies and qualifications

PRODUCT OVERVIEW

Mini-Circuits' RCBT-63H+ is a surface mount bias tee providing high DC voltage/current handling and low insertion loss for applications over a very wide frequency range from 900 to 6000 MHz. This model is capable of handling up to +30 dBm (1W) RF input power, 50V DC voltage and 2.5A DC current. RCBT-63H+ is enclosed in a small package of 0.31"x 0.25", saving significant space on customers' PCB.

KEY FEATURES

Feature	Advantages
Wideband, 900 MHz to 6 GHz	Supports a wide range of applications with a single device, including biasing broadband amplifier, laser diodes, active antennas and more.
Low insertion loss, 0.3 dB typ.	Preserves signal strength from input to output and minimizes overall system loss
Excellent return loss, 18 dB typ.	Provides excellent matching for 50Ω systems, with minimal signal reflection.
RF power handling up to 1 W	This model supports applications with a variety of power requirements.
High DC current handling, 2.5A	RCBT-63H+ supports systems/applications with high DC current requirements.



SURFACE MOUNT Bias Tee

RCBT-63H+

50Ω Wideband 900 MHz to 6 GHz

ELECTRICAL SPECIFICATIONS AT 25°C

Parameter	Frequency (MHz)	Min.	Typ.	Max.	Unit
Frequency Range		900		6000	MHz
Insertion Loss	900-1200	-	0.3	0.6	dB
	1200-5700	-	0.2	0.5	
	5700-6000	-	0.4	0.7	
Isolation	900-4800	20	23	-	dB
	4800-6000	14	17	-	
VSWR	900-1200	-	1.5	1.8	:1
	1200-5700	-	1.3	1.5	
	5700-6000	-	1.4	1.7	

MAXIMUM RATINGS

Operating Temperature	-40 °C to 85 °C
Storage Temperature	-55 °C to 100 °C
RF Power	30 dBm max.
Voltage at DC port	50 V max.
Input Current	2.5A max.

Permanent damage may occur if any of these limits are exceeded.

FUNCTIONAL SCHEMATIC

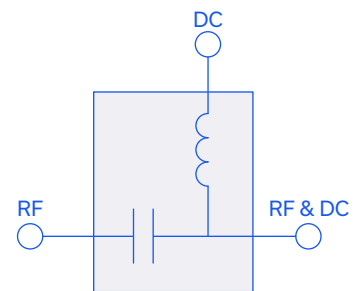



SURFACE MOUNT Bias Tee

RCBT-63H+

Mini-Circuits

50Ω Wideband 900 MHz to 6 GHz

PAD CONNECTIONS

RF	4
RF & DC	3
DC	1
NOT USED	2,5,6

PRODUCT MARKING: N/A

DEMO BOARD MCL P/N: TB-907+
SUGGESTED PCB LAYOUT (PL-577)

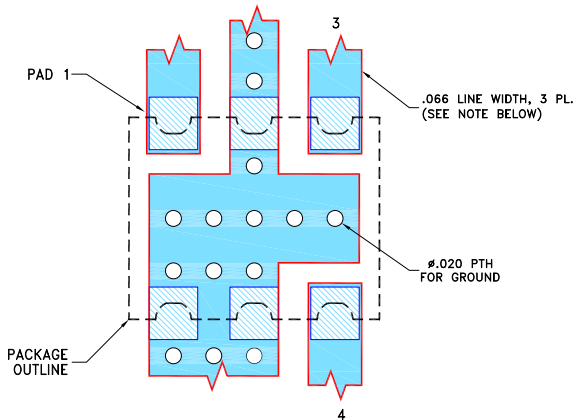

- NOTES:
1. LINE WIDTH IS SHOWN FOR ROGERS R04350B WITH DIELECTRIC THICKNESS $.030 \pm .002$ ". COPPER: 1/2 OZ. EACH SIDE.
FOR OTHER MATERIALS LINE WIDTH MAY NEED TO BE MODIFIED.
 2. DIMENSIONS ARE FOR THE COMPONENT SIDE OF THE PCB.
 3. BOTTOM SIDE OF THE PCB IS CONTINUOUS GROUND PLANE.

- DENOTES PCB COPPER LAYOUT WITH SMOBC (SOLDER MASK OVER BARE COPPER).
- DENOTES COPPER LAND PATTERN FREE OF SOLDER MASK.

OUTLINE DRAWING

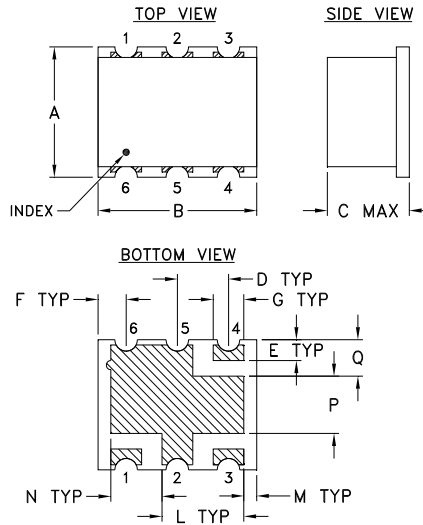

PCB Land Pattern

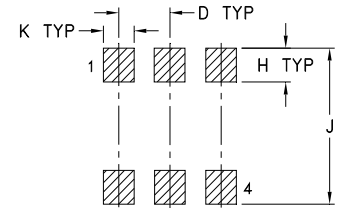

Suggested Layout,
Tolerance to be within .002

OUTLINE DIMENSIONS (Inches mm)

A	B	C	D	E	F	G	H
.25	.31	.16	.100	.040	.055	.060	.065
6.35	7.87	4.06	2.54	1.02	1.40	1.52	1.65
J	K	L	M	N	P	Q	wt.
.300	.060	.160	.025	.100	.110	.070	grams
7.62	1.52	4.06	0.64	2.54	2.79	1.78	0.16



SURFACE MOUNT Bias Tee

RCBT-63H+

50Ω Wideband 900 MHz to 6 GHz

TYPICAL PERFORMANCE DATA

Frequency (MHz)	Insertion Loss (dB) RF & DC-RF	Isolation (dB) RF	VSWR (:1) RF & DC - DC
900	0.42	24.24	1.65
950	0.39	24.20	1.60
1000	0.37	24.18	1.55
1200	0.30	24.33	1.40
1500	0.22	24.65	1.26
2000	0.17	24.76	1.13
2200	0.16	24.80	1.11
2500	0.17	24.88	1.09
3000	0.15	25.02	1.09
3200	0.15	25.01	1.09
3500	0.14	25.00	1.11
4000	0.14	24.75	1.12
4200	0.14	24.46	1.13
4500	0.14	23.95	1.14
4800	0.15	23.21	1.15
5000	0.16	22.66	1.17
5200	0.17	22.10	1.18
5500	0.20	20.95	1.21
5700	0.25	19.84	1.24
6000	0.43	17.32	1.40

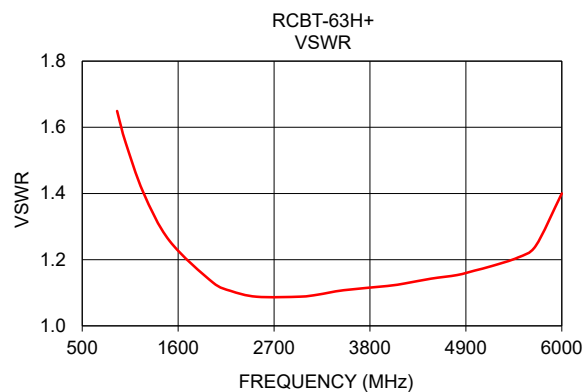
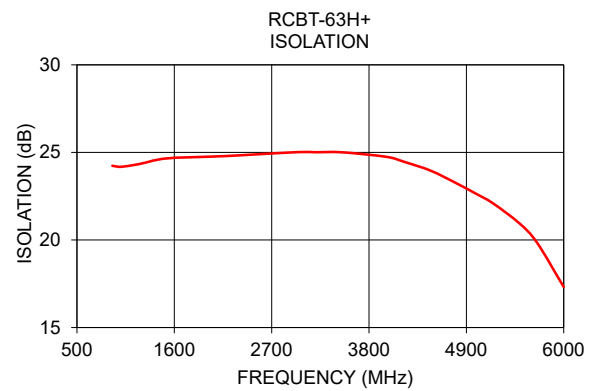
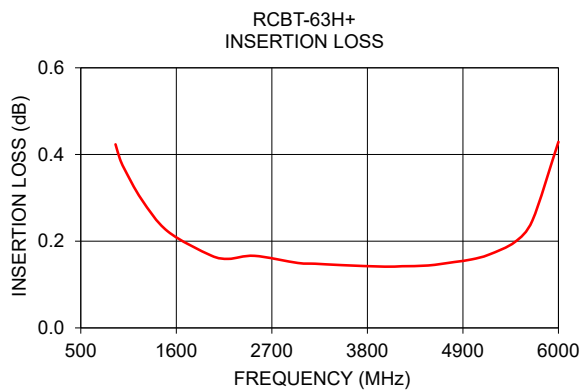

NOTES

- Performance and quality attributes and conditions not expressly stated in this specification document are intended to be excluded and do not form a part of this specification document.
- Electrical specifications and performance data contained in this specification document are based on Mini-Circuit's applicable established test performance criteria and measurement instructions.
- The parts covered by this specification document are subject to Mini-Circuits standard limited warranty and terms and conditions (collectively, "Standard Terms"); Purchasers of this part are entitled to the rights and benefits contained therein. For a full statement of the standard. Terms and the exclusive rights and remedies thereunder, please visit Mini-Circuits' website at www.minicircuits.com/terms/viewterm.html

