

Surface Mount Digital Step Attenuator

DAT-31R5A+ Series

50Ω 0 to 31.5 dB, 0.5 dB Step DC to 4.0 GHz

The Big Deal

- Wideband, operates up to 4 GHz
- Immune to latchup
- High IP3, 52 dBm



CASE STYLE: DG983-2

Product Overview

The DAT-31R5A+ series of 50Ω digital step attenuators provides adjustable attenuation from 0 to 31.5 dB in 0.5 dB steps. The control is a 6-bit serial/parallel interface, and the attenuators operate with either single positive or dual (positive and negative) supply voltage. DAT-31R5A+ series models are produced by a unique CMOS process on silicon, offering the performance of GaAs with the advantages of conventional CMOS devices.

Key Features

| Feature | Advantages |
|--|---|
| Wideband operation, specified from DC to 4.0 GHz | Can be used in multiple applications such as communications, satellite and defense, reducing part count. |
| Serial or parallel interface | Models available with serial or parallel interface mode to suit customer demand. |
| Good VSWR, 1.2:1 typ. | Eases interfacing with adjacent components and results in low amplitude ripple. |
| Single positive supply models: (Model suffixes: -SN+ and -PN+) +2.3 to +3.6V+ | Use of single positive supply simplifies power supply design. An internal negative voltage generator supplies the desired negative voltage. Single positive supply results in excellent spurious performance, -140 dBm typical. |
| Dual supply models: (Model suffixes: -SN+ and -PN+) +2.7 to +3.6V (Positive) and -3.6 to -3.2V (Negative) | Dual supply provides spurious-free operation. It also allows fast switching up to 1 MHz (vs. 25 kHz for single supply). |
| Useable over a wide range of supply voltages, +2.3/2.7 to 5.2V | Wide range of positive operating voltages allows the DAT-31R5A+ Series of models to be used in a wide range of applications. See Application Note AN-70-006 for operation above +3.6V |
| Footprint compatible to DAT-31R5-XX+ Series (XX=SN/SP/PN/PP) | Can fit into existing footprint and provide wideband performance, to 4 GHz instead of 2.4 GHz. |
| Safe attenuation transitions | The DAT-31R5A-XX+ series is designed to prevent any momentary positive 'spikes' in power during attenuation transitions |



Digital Step Attenuator

50Ω DC-4000 MHz

31.5 dB, 0.5 dB Step

6 Bit, Parallel Control Interface, Single Supply Voltage

Product Features

- Immune to latch up
- Excellent accuracy, 0.1 dB Typ
- Low Insertion Loss
- High IP3, +52 dBm Typ
- Very low DC power consumption
- Excellent return loss, 20 dB Typ
- Small size 4.0 x 4.0 mm



Generic photo used for illustration purposes only

DAT-31R5A-PP+

CASE STYLE: DG983-2

Typical Applications

- Base Station Infrastructure
- Portable Wireless
- CATV & DBS
- MMDS & Wireless LAN
- Wireless Local Loop
- UNII & Hiper LAN
- Power amplifier distortion canceling loops

+RoHS Compliant

The +Suffix identifies RoHS Compliance. See our web site for RoHS Compliance methodologies and qualifications

General Description

The DAT-31R5A-PP+ is a 50Ω RF digital step attenuator that offers an attenuation range up to 31.5 dB in 0.5 dB steps. The control is a 6-bit parallel interface, operating on single (positive) supply voltage. The DAT-31R5A-PP+ is produced using a unique CMOS process on silicon, offering the performance of GaAs, with the advantages of conventional CMOS devices.

Simplified Schematic

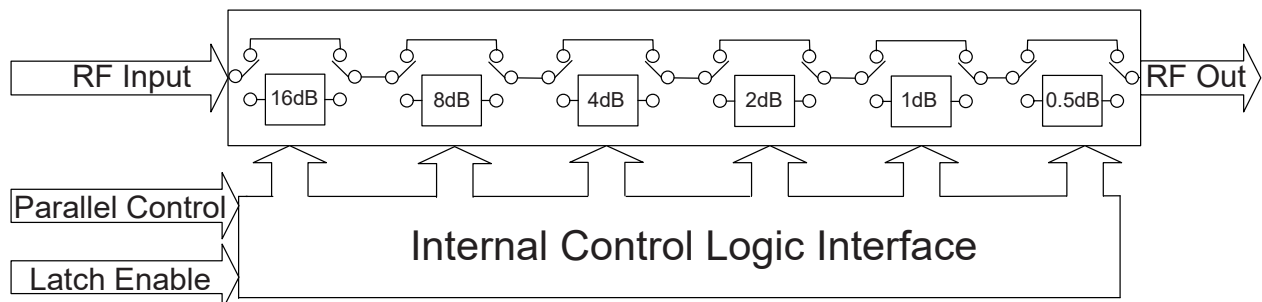

RF Electrical Specifications, DC-4000 MHz, $T_{AMB}=25^{\circ}\text{C}$, $V_{DD}=+3\text{V}$

| Parameter | Freq. Range (GHz) | Min. | Typ. | Max. | Units |
|---|-------------------|------|------|------------|-------|
| Accuracy @ 0.5 dB Attenuation Setting | DC-1 | — | 0.03 | 0.1 | dB |
| | 1-2.4 | — | 0.05 | 0.15 | |
| | 2.4-4 | — | 0.07 | 0.2 | |
| Accuracy @ 1 dB Attenuation Setting | DC-1 | — | 0.02 | 0.1 | dB |
| | 1-2.4 | — | 0.05 | 0.15 | |
| | 2.4-4 | — | 0.1 | 0.25 | |
| Accuracy @ 2 dB Attenuation Setting | DC-1 | — | 0.05 | 0.15 | dB |
| | 1-2.4 | — | 0.15 | 0.25 | |
| | 2.4-4 | — | 0.15 | 0.35 | |
| Accuracy @ 4 dB Attenuation Setting | DC-1 | — | 0.07 | 0.2 | dB |
| | 1-2.4 | — | 0.15 | 0.25 | |
| | 2.4-4 | — | 0.23 | 0.5 | |
| Accuracy @ 8 dB Attenuation Setting | DC-1 | — | 0.03 | 0.2 | dB |
| | 1-2.4 | — | 0.15 | 0.5 | |
| | 2.4-4 | — | 0.6 | 0.8 | |
| Accuracy @ 16 dB Attenuation Setting | DC-1 | — | 0.1 | 0.3 | dB |
| | 1-2.4 | — | 0.15 | 0.7 | |
| | 2.4-4 | — | 1.1 | 1.45 | |
| Insertion Loss (note 2) @ all attenuator set to 0dB | DC-1 | — | 1.3 | 1.9 | dB |
| | 1-2.4 | — | 1.6 | 2.4 | |
| | 2.4-4 | — | 2.1 | 3.0 | |
| Input IP3 (note 3) (at Min. and Max. Attenuation) | DC-4 | — | +52 | — | dBm |
| Input Power @ 0.2dB Compression (Note 3) (at Min. and Max. Attenuation) | DC-4 | — | +24 | — | dBm |
| Input Operating Power | 10 kHz to 50 MHz | — | — | See Fig. 1 | dBm |
| | >50 MHz | — | — | +24 | |
| VSWR | DC-1 | — | 1.2 | 1.5 | :1 |
| | 1-2.4 | — | 1.2 | 1.6 | |
| | 2.4-4 | — | 1.4 | 1.9 | |

Notes:

1. Tested on Evaluation Board TB-334, See Figure 3.
2. Insertion loss values are de-embedded from test board Loss (test board's Insertion Loss: 0.10dB @ 100MHz, 0.35dB @ 1000MHz, 0.60dB @ 2400MHz, 0.75dB @ 4000MHz).
3. Input IP3 and 1dB compression degrade below 1 MHz. Input power not to exceed max operating specification for continuous operation.

DC Electrical Specifications

| Parameter | Min. | Typ. | Max. | Units |
|---------------------------|------|------|-------------------------|---------------|
| V_{DD} , Supply Voltage | 2.3 | 3 | 3.6 ^(Note 4) | V |
| I_{DD} Supply Current | — | — | 200 | μA |
| Control Input Low | -0.3 | — | +0.6 | V |
| Control Input High | 1.17 | — | 3.6 | V |
| Control Current | — | — | 20 ^(Note 5) | μA |

4. For operation above +3.6V, see Application Note AN-70-006
5. Except, 30 μA typ for C0.5, C16, PUP1 at +3.6V

Absolute Maximum Ratings^(Note 6,7)

| Parameter | Ratings |
|------------------------------|-----------------------|
| Operating Temperature | -40°C to 105°C |
| Storage Temperature | -65°C to 150°C |
| V_{DD} | -0.3V Min., 5.5V Max. |
| Voltage on any control input | -0.3V Min., 3.6V Max. |
| Input Power | +30dBm |
| Thermal Resistance | 37°C/W |

6. Permanent damage may occur if any of these limits are exceeded.
7. Operation between max operating and absolute max input power will result in reduced reliability.

Switching Specifications

| Parameter | Min. | Typ. | Max. | Units |
|--|------|------|------|-----------------|
| Switching Speed, 50% Control to 0.5dB of Attenuation Value | — | 1.0 | — | μSec |
| Switching Control Frequency | — | — | 25 | kHz |

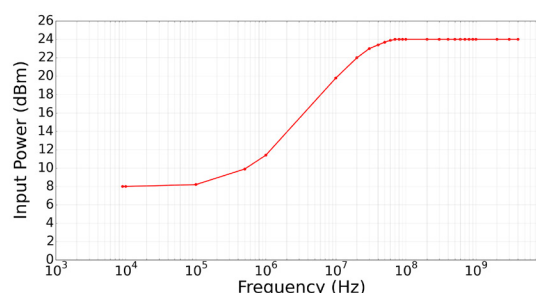

Figure 1. Max Input Operating Power vs Frequency

Pin Description

| Function | Pin Number | Description |
|-----------------|------------|---|
| C16 | 1 | Control for Attenuation bit, 16dB (Note 3, 7) |
| RF in | 2 | RF in port (Note 1) |
| N/C | 3 | Not connected (Note 4) |
| GND | 4 | Ground connection |
| LE | 5 | Latch Enable Input (Note 2) |
| V _{DD} | 6 | Positive Supply Voltage |
| PUP1 | 7 | Power-up selection (Note 7) |
| PUP2 | 8 | Power-up selection |
| V _{DD} | 9 | Positive Supply Voltage |
| GND | 10 | Ground connection |
| GND | 11 | Ground connection |
| GND | 12 | Ground connection (Note 6) |
| GND | 13 | Ground connection |
| RF out | 14 | RF out port (Note 1) |
| C8 | 15 | Control for attenuation bit, 8 dB |
| C4 | 16 | Control for attenuation bit, 4 dB |
| C2 | 17 | Control for attenuation bit, 2 dB |
| GND | 18 | Ground Connection |
| C1 | 19 | Control for attenuation bit, 1 dB |
| C0.5 | 20 | Control for attenuation bit, 0.5 dB (Note 7) |
| GND | Paddle | Paddle ground (Note 5) |

Notes:

- Both RF ports must be held at 0VDC or DC blocked with an external series capacitor.
- Latch Enable (LE) has an internal 2MΩ to internal positive supply voltage.
- Place a 10KΩ resistor in series, as close to pin as possible to avoid freq. resonance.
- Place a shunt 10KΩ resistor to GND
- The exposed solder pad on the bottom of the package (See Pin configuration) must be grounded for proper device operation.
- Ground must be less than 80 mil (0.08") from Pin 12 for proper device operation.
- This pin has an internal 200 kΩ resistor to ground.

Pin Configuration (Top View)

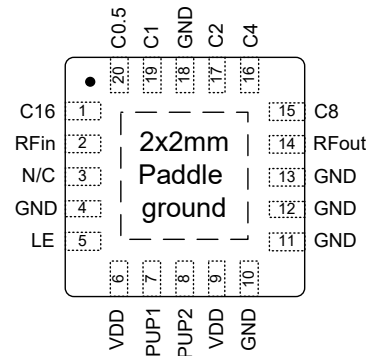

Device Marking

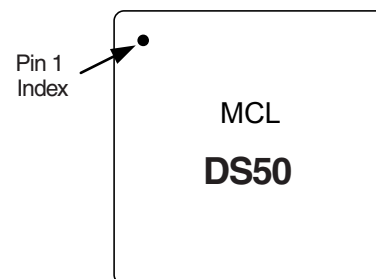

Simplified Schematic

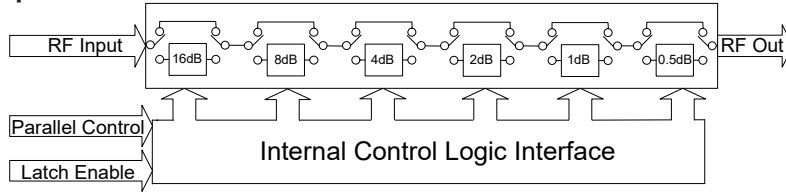

The DAT-31R5A-PP+ parallel interface consists of 6 control bits that select the desired attenuation state, as shown in Table 1: Truth Table

| Table 1. Truth Table | | | | | | |
|----------------------|-----|----|----|----|----|------|
| Attenuation State | C16 | C8 | C4 | C2 | C1 | C0.5 |
| Reference | 0 | 0 | 0 | 0 | 0 | 0 |
| 0.5 (dB) | 0 | 0 | 0 | 0 | 0 | 1 |
| 1 (dB) | 0 | 0 | 0 | 0 | 1 | 0 |
| 2 (dB) | 0 | 0 | 0 | 1 | 0 | 0 |
| 4 (dB) | 0 | 0 | 1 | 0 | 0 | 0 |
| 8 (dB) | 0 | 1 | 0 | 0 | 0 | 0 |
| 16 (dB) | 1 | 0 | 0 | 0 | 0 | 0 |
| 31.5 (dB) | 1 | 1 | 1 | 1 | 1 | 1 |

Note: Not all 64 possible combinations of C0.5 - C16 are shown in table

The parallel interface timing requirements are defined by Figure 2 (Parallel Interface Timing Diagram) and Table 2 (Parallel Interface AC Characteristics), and switching speed.

For latched parallel programming the Latch Enable (LE) should be held LOW while changing attenuation state control values, then pulse LE HIGH to LOW (per Figure 1) to latch new attenuation state into device.

For direct parallel programming, the Latch Enable (LE) line should be pulled HIGH. Changing attenuation state control values will change device state to new attenuation. Direct mode is ideal for manual control of the device (using hardware, switches, or jumpers).

Figure 2: Parallel Interface Timing Diagram

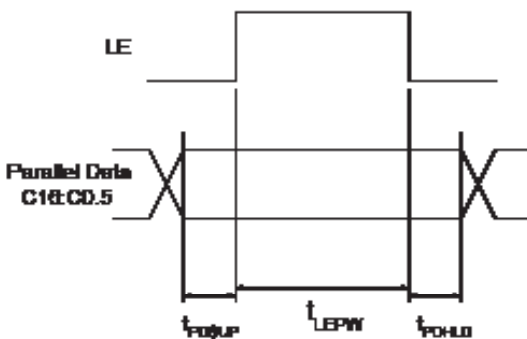

Table 2. Parallel Interface AC Characteristics

| Symbol | Parameter | Min. | Max. | Units |
|-------------|---|------|------|-------|
| t_{LEPW} | LE minimum pulse width | 10 | | ns |
| t_{PDSUP} | Data set-up time before clock rising edge of LE | 10 | | ns |
| t_{PDHLD} | Data hold time after clock falling edge of LE | 10 | | ns |

Power-up Control Settings

The DAT-31R5A-PP+ always assumes a specifiable attenuation setting on power-up, allowing a known attenuation state to be established before an initial parallel control word is provided.

When the attenuator powers up with LE=0, the control bits are automatically set to one of four possible values. These four values are selected by the two power-up control bits, PUP1 and PUP2, as shown in Table 3: (Power-Up Truth Table, Parallel Mode).

| Table 3. Power-Up Truth Table, Parallel Mode | | | |
|---|-------------|-------------|-----------|
| Attenuation State | PUP1 | PUP2 | LE |
| Reference | 0 | 0 | 0 |
| 8 (dB) | 0 | 1 | 0 |
| 16 (dB) | 1 | 0 | 0 |
| 31.5 (dB) | 1 | 1 | 0 |
| Defined by C0.5-C16 (See Table 1-Truth Table) | X (Note 1) | X (Note 1) | 1 |

Note 1: PUP1 and PUP2 Connection may be 0, 1, GROUND, or not connect, without effect on attenuation state.

Power-Up with LE=1 provides normal parallel operation with C0.5-C16, and PUP1 and PUP2 are not active.

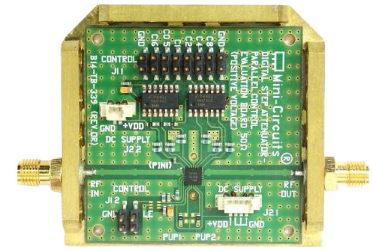
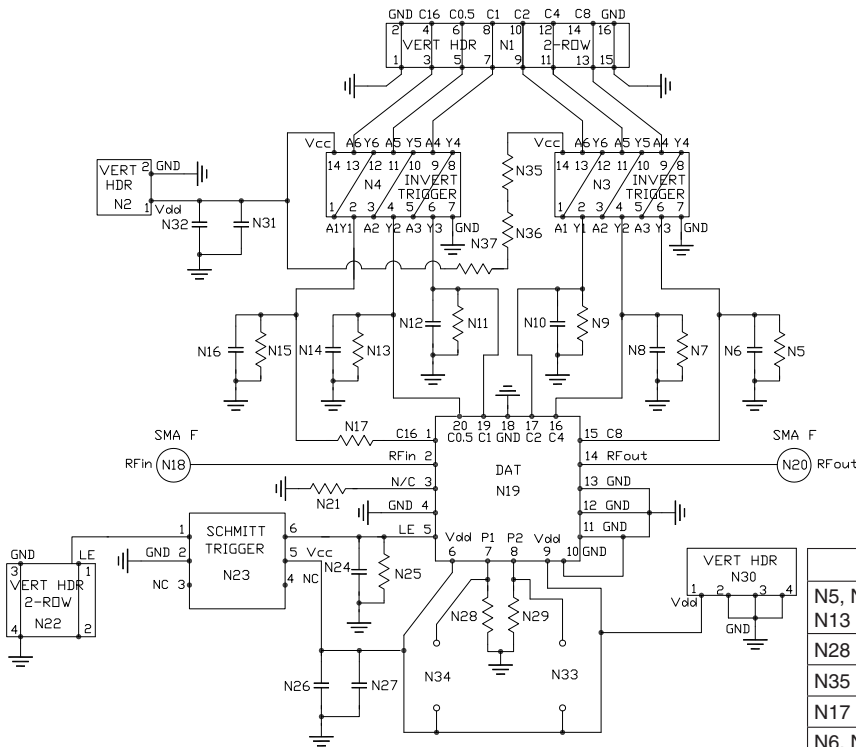

TB-339

| Bill of Materials | |
|--|--|
| N5, N7, N9, N11, N13, N15, N21 & N25 | Resistor 0603 10 KOhm ± 1% |
| N28 & N29 | Resistor 0603 475 Ohm ± 1% |
| N35 - N37 | Resistor 0603 0 Ohm |
| N17 | Resistor 0402 10 KOhm ± 1% |
| N6, N8, N10, N12, N14, N16, N24, N26 & N32 | NPO Capacitor 0603 100pF ± 5% |
| N27 & N31 | Tantalum Capacitor 0805 100nF ± 10% |
| N3 & N4 | Hex Invert Trigger MSL1 |
| N23 | Dual Schmitt Trigger Buffer SC-70 MSL1 |

Notes

- Both RF ports must be held at 0VDC or DC blocked with an external series capacitor.
- Test Board TB-339 is designed for operation for VDD=2.3 to 3.6V. For operation over 3.6V to 5.2V, See Application Note AN-70-006
- VDD=Vdd

Fig 3. Evaluation Board Schematic, TB-339, used for characterization (DUT not soldered on TB-339)

Test Equipment

- For Insertion Loss, Isolation and Return Loss:** Agilent's E5071C Network Analyzer & E3631A Power Supply.
- For Compression:** Agilent's N9020A Signal Analyzer, E8247C RF Generator, E3631A Power Supply & U2004A Power Sensor.
- For Input IP3:** Agilent's N9020A Signal Analyzer, N5181A Signal Generators, E3631A Power Supply, U2004A Power Sensor.
- For Spurs:** Agilent N5181A Signal Generator, E4440A Spectrum Analyzer.
- For Switching Time:** Agilent's N5181A Signal Generator, 81110A Pulse Generator, 54832B Oscilloscope, E3631A Power Supply.
- For Max Control Frequency:** Agilent's N5181A Signal Generator, N9020A Signal Analyzer, E3631A Power Supply, 81110A Pulse Generator.

Measurement Conditions

- For Insertion Loss, Isolation and Return Loss:** VDD=+2.3/+3/+5.5V & Pin=0dBm
- For Compression:** Pin=0/+24dBm. VDD=+3V
- For Input IP3:** Pin=+10dBm/tone. Tone spacing: 0.1 MHz to 1 MHz RF Freq and 1 MHz to 4200 MHz RF Freq, VDD=+3V
- For Spurs:** RF IN at 1000MHz and -20dBm. VDD=+3V
- For Switching Time:** RF Freq=501MHz/0dBm, Pulse for LE=1Hz/0/+3.4V, Delay=500ms, Width=500ms. VDD=+3V
- For Max Control Frequency:** RF Freq=501MHz, 0dBm. VDD=+3V

| Additional Detailed Technical Information | |
|---|--|
| <i>additional information is available on our dash board. To access this information click here</i> | |
| Performance Data | Data Table |
| | Swept Graphs |
| | S-Parameter (S2P Files) Data Set (.zip file) |
| Case Style | DG983-2 <i>Plastic package, exposed paddle, lead finish: NiPdAu</i> |
| Tape & Reel Standard quantities available on reel | F87 <i>7" reels with 20, 50, 100 or 200 devices</i> <i>13" reels with 3K devices</i> |
| Suggested Layout for PCB Design | PL-180 |
| Evaluation Board | TB-339 |
| Environmental Ratings | ENV33T1 |

ESD Rating

Human Body Model (HBM): Class 1C (1000 to <2000V) in accordance with MIL-STD-883 method 3015

MSL Rating

Moisture Sensitivity: MSL1 in accordance with IPC/JEDEC J-STD-020D

MSL Test Flow Chart



Additional Notes

- Performance and quality attributes and conditions not expressly stated in this specification document are intended to be excluded and do not form a part of this specification document.
- Electrical specifications and performance data contained in this specification document are based on Mini-Circuit's applicable established test performance criteria and measurement instructions.
- The parts covered by this specification document are subject to Mini-Circuits standard limited warranty and terms and conditions (collectively, "Standard Terms"); Purchasers of this part are entitled to the rights and benefits contained therein. For a full statement of the Standard Terms and the exclusive rights and remedies thereunder, please visit Mini-Circuits' website at www.minicircuits.com/MCLStore/terms.jsp

Digital Step Attenuator

DAT-31R5A-PP+

Typical Performance Data

TEST CONDITIONS: INPUT POWER=0 dBm, Vdd=+3V, TEMPERATURE=-40°C

| FREQUENCY (MHz) | STEP ATTENUATION* AT TTL CONTROL STATE (dB) | | | | | | | |
|--------------------|--|------------------|------------------|------------------|------------------|------------------|-----------------|-------------------|
| | 000000 THRU LOSS | 000001 0.5 dB | 000010 1.0 dB | 000100 2.0 dB | 001000 4.0 dB | 010000 8.0 dB | 100000 16 dB | 111111 31.5 dB |
| 0.1 | 1.02 | 0.54 | 1.05 | 2.06 | 4.08 | 8.09 | 16.01 | 31.62 |
| 0.3 | 1.01 | 0.54 | 1.05 | 2.06 | 4.09 | 8.10 | 16.02 | 31.64 |
| 0.5 | 1.01 | 0.54 | 1.05 | 2.06 | 4.09 | 8.10 | 16.02 | 31.63 |
| 1 | 1.01 | 0.54 | 1.05 | 2.06 | 4.09 | 8.09 | 16.01 | 31.64 |
| 5 | 1.04 | 0.54 | 1.04 | 2.05 | 4.08 | 8.08 | 16.00 | 31.63 |
| 10 | 1.04 | 0.54 | 1.04 | 2.05 | 4.08 | 8.08 | 16.00 | 31.62 |
| 50 | 1.06 | 0.54 | 1.04 | 2.05 | 4.08 | 8.07 | 16.00 | 31.61 |
| 100 | 1.06 | 0.54 | 1.04 | 2.05 | 4.07 | 8.07 | 15.99 | 31.60 |
| 200 | 1.07 | 0.54 | 1.04 | 2.05 | 4.07 | 8.07 | 15.99 | 31.60 |
| 300 | 1.07 | 0.54 | 1.04 | 2.05 | 4.08 | 8.08 | 16.01 | 31.61 |
| 400 | 1.07 | 0.54 | 1.04 | 2.05 | 4.08 | 8.08 | 16.01 | 31.61 |
| 500 | 1.08 | 0.54 | 1.04 | 2.05 | 4.08 | 8.09 | 16.02 | 31.59 |
| 600 | 1.10 | 0.54 | 1.04 | 2.05 | 4.08 | 8.08 | 16.01 | 31.54 |
| 700 | 1.12 | 0.54 | 1.04 | 2.05 | 4.07 | 8.08 | 16.00 | 31.48 |
| 800 | 1.15 | 0.54 | 1.04 | 2.05 | 4.07 | 8.08 | 15.99 | 31.41 |
| 900 | 1.18 | 0.54 | 1.04 | 2.05 | 4.07 | 8.08 | 15.99 | 31.33 |
| 1000 | 1.20 | 0.54 | 1.04 | 2.05 | 4.07 | 8.09 | 16.00 | 31.34 |
| 1100 | 1.21 | 0.54 | 1.04 | 2.05 | 4.07 | 8.09 | 16.01 | 31.39 |
| 1200 | 1.23 | 0.54 | 1.04 | 2.05 | 4.07 | 8.10 | 16.04 | 31.52 |
| 1300 | 1.25 | 0.54 | 1.04 | 2.05 | 4.07 | 8.11 | 16.04 | 31.49 |
| 1400 | 1.27 | 0.54 | 1.04 | 2.05 | 4.07 | 8.12 | 16.08 | 31.59 |
| 1500 | 1.30 | 0.54 | 1.04 | 2.05 | 4.08 | 8.13 | 16.10 | 31.63 |
| 1600 | 1.32 | 0.54 | 1.04 | 2.05 | 4.08 | 8.14 | 16.12 | 31.64 |
| 1700 | 1.35 | 0.54 | 1.05 | 2.06 | 4.09 | 8.16 | 16.15 | 31.66 |
| 1800 | 1.36 | 0.55 | 1.05 | 2.06 | 4.09 | 8.18 | 16.17 | 31.65 |
| 1900 | 1.37 | 0.55 | 1.06 | 2.07 | 4.11 | 8.21 | 16.22 | 31.66 |
| 2000 | 1.38 | 0.55 | 1.06 | 2.08 | 4.13 | 8.24 | 16.27 | 31.69 |
| 2100 | 1.40 | 0.56 | 1.07 | 2.09 | 4.15 | 8.29 | 16.34 | 31.73 |
| 2200 | 1.42 | 0.56 | 1.08 | 2.11 | 4.17 | 8.33 | 16.40 | 31.73 |
| 2300 | 1.44 | 0.57 | 1.08 | 2.12 | 4.19 | 8.38 | 16.47 | 31.72 |
| 2400 | 1.45 | 0.57 | 1.09 | 2.14 | 4.22 | 8.43 | 16.55 | 31.80 |
| 2500 | 1.46 | 0.58 | 1.10 | 2.15 | 4.24 | 8.49 | 16.63 | 31.77 |
| 2600 | 1.48 | 0.58 | 1.11 | 2.16 | 4.26 | 8.54 | 16.70 | 31.69 |
| 2700 | 1.50 | 0.58 | 1.11 | 2.17 | 4.28 | 8.59 | 16.77 | 31.71 |
| 2800 | 1.52 | 0.58 | 1.11 | 2.17 | 4.28 | 8.62 | 16.81 | 31.60 |
| 2900 | 1.53 | 0.58 | 1.11 | 2.17 | 4.28 | 8.64 | 16.87 | 31.63 |
| 3000 | 1.53 | 0.58 | 1.10 | 2.15 | 4.26 | 8.65 | 16.89 | 31.64 |
| 3200 | 1.52 | 0.56 | 1.08 | 2.12 | 4.22 | 8.64 | 16.92 | 31.49 |
| 3400 | 1.55 | 0.55 | 1.05 | 2.09 | 4.17 | 8.60 | 16.87 | 31.09 |
| 3600 | 1.62 | 0.54 | 1.04 | 2.06 | 4.13 | 8.58 | 16.86 | 31.18 |
| 3800 | 1.70 | 0.54 | 1.03 | 2.05 | 4.12 | 8.61 | 16.93 | 30.92 |
| 4000 | 1.76 | 0.54 | 1.03 | 2.05 | 4.11 | 8.62 | 16.92 | 31.00 |
| 4200 | 1.77 | 0.54 | 1.03 | 2.06 | 4.13 | 8.67 | 17.02 | 31.14 |
| 4400 | 1.84 | 0.55 | 1.04 | 2.08 | 4.16 | 8.78 | 17.28 | 32.03 |
| 4600 | 1.89 | 0.56 | 1.06 | 2.11 | 4.22 | 8.94 | 17.69 | 32.98 |
| 4800 | 1.94 | 0.57 | 1.09 | 2.15 | 4.29 | 9.13 | 18.04 | 32.99 |
| 5000 | 1.97 | 0.58 | 1.07 | 2.19 | 4.36 | 9.33 | 18.42 | 32.53 |

* Step Attenuation above Thru Loss (TTL Logic 00000).



REV. B
DAT-31R5A-PP+
6/13/2016

P.O. Box 350166, Brooklyn, New York 11235-0003 (718) 934-4500 • Fax (718) 332-4661 For detailed performance specs & shopping online see Mini-Circuits web site
The Design Engineers Search Engine Provides ACTUAL Data Instantly From MINI-CIRCUITS At: www.minicircuits.com



IF/RF MICROWAVE COMPONENTS

Digital Step Attenuator

DAT-31R5A-PP+

Typical Performance Data

TEST CONDITIONS: INPUT POWER=0 dBm, Vdd=+3V, TEMPERATURE=-40°C

| FREQUENCY (MHz) | INPUT RETURN LOSS AT TTL CONTROL STATE (dB) | | | | | | | |
|--------------------|--|------------------|------------------|------------------|------------------|------------------|-----------------|-------------------|
| | 000000 0 dB | 000001 0.5 dB | 000010 1.0 dB | 000100 2.0 dB | 001000 4.0 dB | 010000 8.0 dB | 100000 16 dB | 111111 31.5 dB |
| 0.1 | 19.00 | 20.76 | 22.53 | 20.82 | 22.40 | 27.13 | 35.92 | 29.77 |
| 0.3 | 19.19 | 20.95 | 22.75 | 21.04 | 22.65 | 27.42 | 35.75 | 29.71 |
| 0.5 | 19.22 | 20.98 | 22.80 | 21.06 | 22.69 | 27.58 | 35.46 | 29.73 |
| 1 | 19.31 | 21.08 | 22.91 | 21.13 | 22.72 | 27.53 | 35.46 | 29.68 |
| 5 | 19.24 | 21.02 | 22.83 | 21.06 | 22.63 | 27.38 | 35.60 | 29.70 |
| 10 | 19.22 | 21.00 | 22.81 | 21.03 | 22.60 | 27.34 | 35.73 | 29.74 |
| 50 | 19.09 | 20.81 | 22.55 | 20.79 | 22.26 | 26.68 | 37.87 | 30.87 |
| 100 | 19.07 | 20.74 | 22.40 | 20.63 | 21.97 | 26.00 | 41.68 | 32.40 |
| 200 | 18.92 | 20.56 | 22.19 | 20.53 | 21.90 | 26.00 | 39.47 | 31.63 |
| 300 | 19.36 | 21.11 | 22.86 | 21.13 | 22.69 | 27.45 | 35.14 | 29.36 |
| 400 | 19.54 | 21.36 | 23.21 | 21.40 | 23.04 | 28.12 | 34.37 | 29.12 |
| 500 | 18.96 | 20.68 | 22.41 | 20.77 | 22.35 | 27.02 | 36.15 | 30.53 |
| 600 | 19.07 | 20.75 | 22.42 | 20.71 | 22.16 | 26.54 | 38.52 | 31.54 |
| 700 | 19.21 | 20.86 | 22.50 | 20.75 | 22.13 | 26.44 | 39.50 | 31.83 |
| 800 | 19.11 | 20.69 | 22.24 | 20.52 | 21.81 | 25.90 | 42.91 | 32.90 |
| 900 | 18.91 | 20.40 | 21.84 | 20.25 | 21.53 | 25.56 | 47.22 | 32.51 |
| 1000 | 18.65 | 20.07 | 21.41 | 19.98 | 21.28 | 25.36 | 44.98 | 31.53 |
| 1100 | 18.40 | 19.74 | 20.99 | 19.69 | 20.98 | 25.05 | 42.45 | 30.72 |
| 1200 | 18.21 | 19.45 | 20.59 | 19.42 | 20.68 | 24.63 | 38.94 | 29.65 |
| 1300 | 17.90 | 19.02 | 20.03 | 19.08 | 20.34 | 24.26 | 34.47 | 27.69 |
| 1400 | 17.95 | 19.01 | 19.94 | 19.16 | 20.50 | 24.66 | 32.17 | 26.18 |
| 1500 | 17.71 | 18.69 | 19.54 | 18.94 | 20.35 | 24.63 | 31.04 | 25.42 |
| 1600 | 17.31 | 18.19 | 18.94 | 18.55 | 19.98 | 24.17 | 29.13 | 24.24 |
| 1700 | 16.82 | 17.61 | 18.28 | 18.11 | 19.58 | 23.70 | 27.36 | 23.06 |
| 1800 | 16.33 | 17.05 | 17.64 | 17.69 | 19.23 | 23.23 | 25.46 | 21.75 |
| 1900 | 16.08 | 16.77 | 17.31 | 17.55 | 19.18 | 23.10 | 23.76 | 20.56 |
| 2000 | 16.13 | 16.81 | 17.32 | 17.68 | 19.37 | 23.13 | 22.52 | 19.69 |
| 2100 | 16.23 | 16.90 | 17.37 | 17.82 | 19.53 | 22.98 | 21.48 | 18.94 |
| 2200 | 16.48 | 17.16 | 17.60 | 18.15 | 19.91 | 23.00 | 20.63 | 18.35 |
| 2300 | 16.84 | 17.57 | 17.99 | 18.60 | 20.40 | 23.00 | 19.88 | 17.84 |
| 2400 | 17.36 | 18.12 | 18.49 | 19.18 | 20.90 | 22.55 | 18.93 | 17.16 |
| 2500 | 18.35 | 19.14 | 19.43 | 20.18 | 21.67 | 21.96 | 17.98 | 16.48 |
| 2600 | 19.85 | 20.80 | 20.95 | 21.79 | 22.94 | 21.59 | 17.27 | 16.01 |
| 2700 | 21.99 | 23.35 | 23.32 | 24.28 | 24.74 | 21.28 | 16.73 | 15.71 |
| 2800 | 24.39 | 27.12 | 27.01 | 28.22 | 26.97 | 20.96 | 16.31 | 15.54 |
| 2900 | 26.82 | 33.66 | 33.19 | 35.61 | 28.31 | 20.39 | 15.88 | 15.33 |
| 3000 | 26.78 | 35.73 | 40.37 | 46.78 | 28.58 | 20.07 | 15.69 | 15.34 |
| 3200 | 23.02 | 26.25 | 28.51 | 28.46 | 26.57 | 19.72 | 15.61 | 15.69 |
| 3400 | 21.46 | 23.85 | 25.67 | 25.65 | 25.57 | 19.96 | 15.93 | 16.32 |
| 3600 | 22.18 | 24.49 | 26.15 | 26.04 | 26.02 | 20.45 | 16.34 | 16.94 |
| 3800 | 23.83 | 26.47 | 28.17 | 27.70 | 27.58 | 21.28 | 16.88 | 17.66 |
| 4000 | 33.02 | 37.20 | 32.64 | 40.99 | 31.83 | 22.03 | 17.21 | 17.70 |
| 4200 | 31.61 | 27.92 | 25.49 | 29.02 | 27.40 | 21.59 | 17.20 | 17.09 |
| 4400 | 22.12 | 20.81 | 19.79 | 21.43 | 21.03 | 18.64 | 15.73 | 15.24 |
| 4600 | 18.52 | 17.66 | 16.95 | 18.09 | 17.76 | 16.23 | 14.16 | 13.48 |
| 4800 | 17.44 | 16.57 | 15.76 | 16.69 | 16.15 | 14.54 | 12.79 | 12.17 |
| 5000 | 16.78 | 15.78 | 15.06 | 15.64 | 14.72 | 12.97 | 11.44 | 11.01 |



REV. B
DAT-31R5A-PP+
6/13/2016

P.O. Box 350166, Brooklyn, New York 11235-0003 (718) 934-4500 • Fax (718) 332-4661 For detailed performance specs & shopping online see Mini-Circuits web site
The Design Engineers Search Engine Provides ACTUAL Data Instantly From MINI-CIRCUITS At: www.minicircuits.com



Digital Step Attenuator

DAT-31R5A-PP+

Typical Performance Data

TEST CONDITIONS: INPUT POWER=0 dBm, Vdd=+3V, TEMPERATURE=-40°C

| FREQUENCY (MHz) | OUTPUT RETURN LOSS AT TTL CONTROL STATE (dB) | | | | | | | |
|--------------------|---|------------------|------------------|------------------|------------------|------------------|-----------------|-------------------|
| | 000000 0 dB | 000001 0.5 dB | 000010 1.0 dB | 000100 2.0 dB | 001000 4.0 dB | 010000 8.0 dB | 100000 16 dB | 111111 31.5 dB |
| 0.1 | 18.65 | 19.43 | 19.78 | 25.66 | 31.47 | 44.42 | 37.54 | 29.00 |
| 0.3 | 18.85 | 19.64 | 20.00 | 25.89 | 31.83 | 45.30 | 38.09 | 29.00 |
| 0.5 | 18.93 | 19.71 | 20.06 | 26.02 | 32.06 | 47.05 | 38.91 | 28.99 |
| 1 | 19.02 | 19.80 | 20.14 | 26.15 | 32.22 | 47.07 | 38.70 | 28.93 |
| 5 | 19.06 | 19.85 | 20.18 | 26.24 | 32.23 | 46.66 | 38.27 | 28.96 |
| 10 | 19.06 | 19.84 | 20.17 | 26.20 | 32.18 | 45.98 | 37.99 | 29.05 |
| 50 | 18.97 | 19.72 | 20.04 | 25.84 | 31.35 | 41.70 | 36.01 | 29.90 |
| 100 | 18.83 | 19.54 | 19.83 | 25.33 | 30.17 | 38.05 | 33.72 | 31.44 |
| 200 | 18.71 | 19.42 | 19.71 | 25.02 | 29.49 | 36.44 | 33.52 | 30.94 |
| 300 | 18.56 | 19.30 | 19.64 | 24.97 | 29.67 | 37.49 | 35.16 | 29.72 |
| 400 | 18.86 | 19.62 | 19.95 | 25.57 | 30.52 | 38.99 | 36.79 | 28.91 |
| 500 | 19.36 | 20.12 | 20.44 | 26.44 | 31.84 | 43.40 | 38.35 | 28.81 |
| 600 | 19.28 | 19.99 | 20.25 | 25.89 | 30.60 | 39.34 | 34.82 | 30.32 |
| 700 | 19.10 | 19.73 | 19.97 | 25.18 | 29.05 | 35.52 | 33.07 | 30.68 |
| 800 | 19.14 | 19.70 | 19.90 | 24.82 | 28.06 | 33.45 | 31.78 | 30.58 |
| 900 | 18.95 | 19.47 | 19.63 | 24.11 | 26.77 | 31.38 | 30.86 | 29.44 |
| 1000 | 18.95 | 19.44 | 19.60 | 23.85 | 26.28 | 30.89 | 31.25 | 28.36 |
| 1100 | 18.79 | 19.26 | 19.42 | 23.50 | 25.88 | 30.67 | 31.33 | 28.15 |
| 1200 | 18.57 | 19.00 | 19.16 | 22.92 | 25.07 | 29.73 | 31.03 | 27.42 |
| 1300 | 18.25 | 18.67 | 18.87 | 22.32 | 24.40 | 29.15 | 31.36 | 26.67 |
| 1400 | 17.70 | 18.13 | 18.36 | 21.54 | 23.57 | 28.29 | 31.32 | 25.86 |
| 1500 | 17.34 | 17.76 | 18.00 | 20.97 | 22.89 | 27.48 | 31.26 | 24.95 |
| 1600 | 16.89 | 17.31 | 17.57 | 20.25 | 22.06 | 26.51 | 30.96 | 23.96 |
| 1700 | 16.39 | 16.80 | 17.09 | 19.49 | 21.17 | 25.35 | 30.24 | 22.74 |
| 1800 | 15.90 | 16.33 | 16.65 | 18.80 | 20.38 | 24.31 | 29.43 | 21.52 |
| 1900 | 15.63 | 16.08 | 16.44 | 18.42 | 19.91 | 23.61 | 28.52 | 20.49 |
| 2000 | 15.63 | 16.11 | 16.50 | 18.43 | 19.87 | 23.40 | 27.86 | 19.89 |
| 2100 | 15.62 | 16.14 | 16.55 | 18.48 | 19.85 | 23.15 | 26.86 | 19.35 |
| 2200 | 15.77 | 16.32 | 16.74 | 18.60 | 19.81 | 22.67 | 25.44 | 18.70 |
| 2300 | 16.19 | 16.76 | 17.21 | 18.99 | 19.96 | 22.22 | 23.97 | 18.09 |
| 2400 | 16.71 | 17.34 | 17.83 | 19.55 | 20.24 | 21.77 | 22.59 | 17.58 |
| 2500 | 17.42 | 18.15 | 18.70 | 20.52 | 20.85 | 21.53 | 21.50 | 17.24 |
| 2600 | 18.48 | 19.36 | 20.00 | 22.08 | 21.79 | 21.37 | 20.61 | 17.04 |
| 2700 | 19.50 | 20.63 | 21.40 | 24.09 | 22.84 | 21.18 | 19.85 | 16.88 |
| 2800 | 20.88 | 22.39 | 23.43 | 27.35 | 24.02 | 20.81 | 19.05 | 16.75 |
| 2900 | 21.49 | 23.42 | 24.81 | 32.93 | 25.45 | 20.64 | 18.49 | 16.87 |
| 3000 | 21.24 | 23.23 | 24.71 | 44.05 | 26.76 | 20.56 | 18.15 | 17.19 |
| 3200 | 19.73 | 21.32 | 22.41 | 30.45 | 27.55 | 20.66 | 17.97 | 17.97 |
| 3400 | 18.48 | 19.72 | 20.50 | 25.88 | 26.81 | 20.76 | 17.90 | 19.26 |
| 3600 | 17.95 | 19.01 | 19.61 | 24.95 | 27.75 | 21.84 | 18.58 | 21.24 |
| 3800 | 17.80 | 18.74 | 19.22 | 25.01 | 29.80 | 23.90 | 19.90 | 23.70 |
| 4000 | 18.51 | 19.31 | 19.64 | 26.34 | 32.89 | 29.07 | 22.47 | 24.59 |
| 4200 | 19.40 | 20.06 | 20.32 | 26.57 | 29.49 | 33.21 | 24.01 | 22.05 |
| 4400 | 20.61 | 21.10 | 21.28 | 24.98 | 24.75 | 26.48 | 22.38 | 18.76 |
| 4600 | 23.70 | 23.92 | 23.97 | 23.77 | 22.06 | 21.45 | 18.95 | 16.56 |
| 4800 | 27.75 | 27.09 | 26.78 | 21.93 | 19.81 | 18.12 | 16.07 | 14.92 |
| 5000 | 32.07 | 28.94 | 27.57 | 20.31 | 18.22 | 15.83 | 13.93 | 13.92 |



REV. B
DAT-31R5A-PP+
6/13/2016

P.O. Box 350166, Brooklyn, New York 11235-0003 (718) 934-4500 • Fax (718) 332-4661 For detailed performance specs & shopping online see Mini-Circuits web site
The Design Engineers Search Engine Provides ACTUAL Data Instantly From MINI-CIRCUITS At: www.minicircuits.com



IF/RF MICROWAVE COMPONENTS

Digital Step Attenuator

DAT-31R5A-PP+

Typical Performance Data

TEST CONDITIONS: INPUT POWER=0 dBm, Vdd=+3V, TEMPERATURE=+25degC

| FREQUENCY (MHz) | STEP ATTENUATION* AT TTL CONTROL STATE (dB) | | | | | | | |
|--------------------|--|------------------|------------------|------------------|------------------|------------------|-----------------|-------------------|
| | 000000 THRU LOSS | 000001 0.5 dB | 000010 1.0 dB | 000100 2.0 dB | 001000 4.0 dB | 010000 8.0 dB | 100000 16 dB | 111111 31.5 dB |
| 0.1 | 1.13 | 0.53 | 1.02 | 2.02 | 4.02 | 7.97 | 15.91 | 31.41 |
| 0.3 | 1.12 | 0.53 | 1.02 | 2.02 | 4.03 | 7.98 | 15.92 | 31.44 |
| 0.5 | 1.12 | 0.53 | 1.02 | 2.02 | 4.03 | 7.98 | 15.92 | 31.43 |
| 1 | 1.12 | 0.53 | 1.02 | 2.02 | 4.02 | 7.97 | 15.91 | 31.40 |
| 5 | 1.15 | 0.52 | 1.02 | 2.01 | 4.02 | 7.97 | 15.90 | 31.39 |
| 10 | 1.15 | 0.52 | 1.02 | 2.01 | 4.02 | 7.97 | 15.91 | 31.41 |
| 50 | 1.16 | 0.52 | 1.02 | 2.01 | 4.02 | 7.97 | 15.91 | 31.40 |
| 100 | 1.16 | 0.52 | 1.02 | 2.01 | 4.02 | 7.97 | 15.91 | 31.40 |
| 200 | 1.16 | 0.52 | 1.02 | 2.01 | 4.02 | 7.97 | 15.91 | 31.40 |
| 300 | 1.17 | 0.52 | 1.02 | 2.01 | 4.02 | 7.97 | 15.91 | 31.39 |
| 400 | 1.18 | 0.52 | 1.02 | 2.01 | 4.01 | 7.97 | 15.91 | 31.38 |
| 500 | 1.19 | 0.52 | 1.02 | 2.01 | 4.01 | 7.97 | 15.91 | 31.37 |
| 600 | 1.21 | 0.52 | 1.01 | 2.01 | 4.01 | 7.97 | 15.91 | 31.34 |
| 700 | 1.22 | 0.52 | 1.01 | 2.01 | 4.01 | 7.97 | 15.91 | 31.30 |
| 800 | 1.24 | 0.52 | 1.01 | 2.01 | 4.01 | 7.97 | 15.91 | 31.24 |
| 900 | 1.26 | 0.52 | 1.01 | 2.01 | 4.01 | 7.97 | 15.91 | 31.20 |
| 1000 | 1.29 | 0.52 | 1.01 | 2.00 | 4.01 | 7.97 | 15.91 | 31.18 |
| 1100 | 1.31 | 0.52 | 1.01 | 2.00 | 4.00 | 7.98 | 15.92 | 31.20 |
| 1200 | 1.34 | 0.52 | 1.01 | 2.00 | 4.00 | 7.98 | 15.93 | 31.25 |
| 1300 | 1.36 | 0.52 | 1.01 | 2.00 | 4.00 | 7.99 | 15.94 | 31.31 |
| 1400 | 1.38 | 0.52 | 1.01 | 2.00 | 4.00 | 7.99 | 15.96 | 31.34 |
| 1500 | 1.41 | 0.52 | 1.01 | 2.00 | 4.00 | 8.00 | 15.97 | 31.39 |
| 1600 | 1.43 | 0.52 | 1.02 | 2.01 | 4.00 | 8.01 | 15.99 | 31.44 |
| 1700 | 1.46 | 0.52 | 1.02 | 2.01 | 4.01 | 8.02 | 16.02 | 31.50 |
| 1800 | 1.48 | 0.53 | 1.02 | 2.02 | 4.01 | 8.04 | 16.05 | 31.55 |
| 1900 | 1.50 | 0.53 | 1.03 | 2.02 | 4.03 | 8.06 | 16.09 | 31.58 |
| 2000 | 1.51 | 0.53 | 1.03 | 2.03 | 4.04 | 8.09 | 16.14 | 31.59 |
| 2100 | 1.53 | 0.54 | 1.04 | 2.04 | 4.06 | 8.13 | 16.20 | 31.63 |
| 2200 | 1.55 | 0.54 | 1.05 | 2.06 | 4.08 | 8.18 | 16.27 | 31.69 |
| 2300 | 1.56 | 0.55 | 1.05 | 2.07 | 4.10 | 8.23 | 16.35 | 31.76 |
| 2400 | 1.57 | 0.55 | 1.06 | 2.09 | 4.12 | 8.28 | 16.43 | 31.77 |
| 2500 | 1.58 | 0.55 | 1.07 | 2.10 | 4.14 | 8.33 | 16.51 | 31.74 |
| 2600 | 1.60 | 0.56 | 1.07 | 2.11 | 4.16 | 8.38 | 16.58 | 31.74 |
| 2700 | 1.62 | 0.56 | 1.07 | 2.11 | 4.17 | 8.43 | 16.66 | 31.77 |
| 2800 | 1.64 | 0.56 | 1.07 | 2.11 | 4.17 | 8.45 | 16.71 | 31.69 |
| 2900 | 1.65 | 0.55 | 1.06 | 2.10 | 4.16 | 8.47 | 16.75 | 31.72 |
| 3000 | 1.66 | 0.55 | 1.06 | 2.09 | 4.15 | 8.49 | 16.79 | 31.77 |
| 3200 | 1.64 | 0.54 | 1.04 | 2.06 | 4.11 | 8.49 | 16.85 | 31.68 |
| 3400 | 1.68 | 0.53 | 1.02 | 2.03 | 4.07 | 8.47 | 16.84 | 31.45 |
| 3600 | 1.75 | 0.52 | 1.01 | 2.01 | 4.04 | 8.47 | 16.86 | 31.37 |
| 3800 | 1.83 | 0.52 | 1.00 | 2.01 | 4.04 | 8.49 | 16.89 | 31.34 |
| 4000 | 1.88 | 0.52 | 1.00 | 2.02 | 4.05 | 8.52 | 16.95 | 31.45 |
| 4200 | 1.91 | 0.52 | 1.01 | 2.03 | 4.06 | 8.58 | 17.08 | 31.87 |
| 4400 | 1.99 | 0.53 | 1.02 | 2.05 | 4.10 | 8.68 | 17.35 | 32.80 |
| 4600 | 2.03 | 0.54 | 1.04 | 2.09 | 4.15 | 8.83 | 17.71 | 33.46 |
| 4800 | 2.07 | 0.55 | 1.06 | 2.12 | 4.21 | 9.03 | 18.14 | 34.07 |
| 5000 | 2.13 | 0.56 | 1.05 | 2.17 | 4.30 | 9.28 | 18.64 | 33.44 |

* Step Attenuation above Thru Loss (TTL Logic 00000).



REV. B
DAT-31R5A-PP+
6/13/2016

P.O. Box 350166, Brooklyn, New York 11235-0003 (718) 934-4500 • Fax (718) 332-4661 For detailed performance specs & shopping online see Mini-Circuits web site
The Design Engineers Search Engine Provides ACTUAL Data Instantly From MINI-CIRCUITS At: www.minicircuits.com



IF/RF MICROWAVE COMPONENTS

Digital Step Attenuator

DAT-31R5A-PP+

Typical Performance Data

TEST CONDITIONS: INPUT POWER=0 dBm, Vdd=+3V, TEMPERATURE=+25degC

| FREQUENCY (MHz) | INPUT RETURN LOSS AT TTL CONTROL STATE (dB) | | | | | | | |
|--------------------|--|------------------|------------------|------------------|------------------|------------------|-----------------|-------------------|
| | 000000 0 dB | 000001 0.5 dB | 000010 1.0 dB | 000100 2.0 dB | 001000 4.0 dB | 010000 8.0 dB | 100000 16 dB | 111111 31.5 dB |
| 0.1 | 18.07 | 19.30 | 20.46 | 18.57 | 19.08 | 21.02 | 29.10 | 34.94 |
| 0.3 | 18.23 | 19.44 | 20.61 | 18.72 | 19.23 | 21.16 | 29.18 | 34.97 |
| 0.5 | 18.23 | 19.45 | 20.61 | 18.73 | 19.24 | 21.20 | 29.26 | 34.96 |
| 1 | 18.32 | 19.53 | 20.71 | 18.78 | 19.28 | 21.18 | 29.26 | 35.06 |
| 5 | 18.28 | 19.51 | 20.69 | 18.75 | 19.24 | 21.15 | 29.23 | 35.08 |
| 10 | 18.26 | 19.50 | 20.67 | 18.74 | 19.23 | 21.15 | 29.20 | 35.04 |
| 50 | 18.22 | 19.44 | 20.60 | 18.70 | 19.19 | 21.08 | 28.98 | 34.60 |
| 100 | 18.31 | 19.53 | 20.67 | 18.76 | 19.23 | 21.11 | 28.92 | 34.43 |
| 200 | 18.25 | 19.47 | 20.60 | 18.73 | 19.19 | 21.05 | 28.62 | 33.93 |
| 300 | 18.29 | 19.50 | 20.62 | 18.72 | 19.15 | 20.94 | 28.14 | 33.20 |
| 400 | 18.42 | 19.61 | 20.70 | 18.76 | 19.13 | 20.84 | 27.71 | 32.52 |
| 500 | 18.45 | 19.61 | 20.70 | 18.73 | 19.07 | 20.73 | 27.28 | 31.89 |
| 600 | 18.48 | 19.62 | 20.68 | 18.68 | 18.98 | 20.54 | 26.66 | 30.99 |
| 700 | 18.41 | 19.50 | 20.50 | 18.51 | 18.75 | 20.21 | 25.87 | 29.75 |
| 800 | 18.34 | 19.38 | 20.32 | 18.34 | 18.52 | 19.89 | 25.22 | 28.60 |
| 900 | 18.25 | 19.24 | 20.13 | 18.20 | 18.36 | 19.71 | 24.91 | 27.87 |
| 1000 | 18.14 | 19.07 | 19.91 | 18.07 | 18.22 | 19.58 | 24.67 | 27.21 |
| 1100 | 17.87 | 18.72 | 19.50 | 17.82 | 18.00 | 19.38 | 24.37 | 26.44 |
| 1200 | 17.61 | 18.38 | 19.07 | 17.59 | 17.79 | 19.21 | 24.11 | 25.61 |
| 1300 | 17.19 | 17.88 | 18.50 | 17.28 | 17.58 | 19.12 | 24.03 | 24.91 |
| 1400 | 16.77 | 17.40 | 17.95 | 17.02 | 17.45 | 19.16 | 24.18 | 24.37 |
| 1500 | 16.27 | 16.85 | 17.36 | 16.71 | 17.28 | 19.21 | 24.32 | 23.83 |
| 1600 | 15.79 | 16.33 | 16.80 | 16.42 | 17.15 | 19.31 | 24.50 | 23.27 |
| 1700 | 15.37 | 15.89 | 16.32 | 16.18 | 17.06 | 19.49 | 24.69 | 22.70 |
| 1800 | 15.04 | 15.54 | 15.94 | 16.00 | 17.05 | 19.77 | 24.86 | 22.16 |
| 1900 | 14.80 | 15.29 | 15.67 | 15.91 | 17.09 | 20.11 | 24.91 | 21.63 |
| 2000 | 14.69 | 15.18 | 15.53 | 15.91 | 17.23 | 20.52 | 24.72 | 21.08 |
| 2100 | 14.80 | 15.29 | 15.62 | 16.14 | 17.59 | 21.15 | 24.31 | 20.50 |
| 2200 | 15.17 | 15.67 | 15.98 | 16.62 | 18.20 | 22.05 | 23.83 | 20.07 |
| 2300 | 15.76 | 16.29 | 16.58 | 17.33 | 19.05 | 23.14 | 23.29 | 19.75 |
| 2400 | 16.50 | 17.07 | 17.33 | 18.17 | 20.02 | 24.15 | 22.52 | 19.36 |
| 2500 | 17.64 | 18.27 | 18.48 | 19.43 | 21.41 | 25.09 | 21.58 | 18.92 |
| 2600 | 19.24 | 20.00 | 20.15 | 21.29 | 23.44 | 25.71 | 20.56 | 18.48 |
| 2700 | 21.48 | 22.60 | 22.73 | 24.13 | 26.70 | 25.97 | 19.79 | 18.26 |
| 2800 | 23.77 | 25.89 | 26.25 | 27.83 | 31.67 | 25.71 | 19.28 | 18.24 |
| 2900 | 25.67 | 29.79 | 31.32 | 32.34 | 39.65 | 24.96 | 18.88 | 18.25 |
| 3000 | 26.36 | 32.77 | 43.12 | 35.44 | 37.95 | 23.73 | 18.34 | 18.12 |
| 3200 | 23.13 | 26.13 | 29.03 | 26.60 | 26.83 | 21.47 | 17.47 | 18.11 |
| 3400 | 20.97 | 23.07 | 25.12 | 23.27 | 23.91 | 20.87 | 17.58 | 19.06 |
| 3600 | 21.06 | 23.11 | 25.14 | 22.86 | 23.39 | 21.01 | 17.95 | 20.15 |
| 3800 | 23.19 | 25.94 | 28.99 | 24.49 | 25.08 | 22.94 | 19.38 | 22.52 |
| 4000 | 27.72 | 31.14 | 32.48 | 28.48 | 31.00 | 28.58 | 21.79 | 24.46 |
| 4200 | 24.50 | 24.08 | 23.22 | 25.48 | 28.42 | 30.76 | 22.55 | 22.01 |
| 4400 | 19.24 | 18.71 | 18.15 | 19.99 | 21.09 | 21.67 | 19.20 | 17.70 |
| 4600 | 16.66 | 16.18 | 15.70 | 17.13 | 17.63 | 17.58 | 16.10 | 14.84 |
| 4800 | 16.02 | 15.39 | 14.79 | 15.98 | 15.91 | 15.04 | 13.69 | 12.86 |
| 5000 | 16.03 | 15.20 | 14.57 | 15.41 | 14.84 | 13.46 | 12.12 | 11.62 |



REV. B
DAT-31R5A-PP+
6/13/2016

P.O. Box 350166, Brooklyn, New York 11235-0003 (718) 934-4500 • Fax (718) 332-4661 For detailed performance specs & shopping online see Mini-Circuits web site
The Design Engineers Search Engine Provides ACTUAL Data Instantly From MINI-CIRCUITS At: www.minicircuits.com

Digital Step Attenuator

DAT-31R5A-PP+

Typical Performance Data

TEST CONDITIONS: INPUT POWER=0 dBm, Vdd=+3V, TEMPERATURE=+25degC

| FREQUENCY (MHz) | OUTPUT RETURN LOSS AT TTL CONTROL STATE (dB) | | | | | | | |
|--------------------|---|------------------|------------------|------------------|------------------|------------------|-----------------|-------------------|
| | 000000 0 dB | 000001 0.5 dB | 000010 1.0 dB | 000100 2.0 dB | 001000 4.0 dB | 010000 8.0 dB | 100000 16 dB | 111111 31.5 dB |
| 0.1 | 17.79 | 18.18 | 18.23 | 22.11 | 24.27 | 25.94 | 23.68 | 37.34 |
| 0.3 | 17.94 | 18.33 | 18.38 | 22.25 | 24.40 | 26.01 | 23.80 | 37.38 |
| 0.5 | 18.01 | 18.39 | 18.44 | 22.33 | 24.48 | 26.11 | 23.89 | 37.31 |
| 1 | 18.10 | 18.47 | 18.51 | 22.41 | 24.53 | 26.11 | 23.83 | 37.43 |
| 5 | 18.14 | 18.53 | 18.55 | 22.47 | 24.58 | 26.12 | 23.83 | 37.44 |
| 10 | 18.15 | 18.53 | 18.56 | 22.47 | 24.56 | 26.09 | 23.80 | 37.32 |
| 50 | 18.09 | 18.49 | 18.51 | 22.40 | 24.46 | 26.00 | 23.75 | 36.80 |
| 100 | 18.04 | 18.42 | 18.45 | 22.27 | 24.29 | 25.79 | 23.61 | 36.02 |
| 200 | 18.08 | 18.45 | 18.48 | 22.25 | 24.23 | 25.67 | 23.51 | 35.44 |
| 300 | 18.17 | 18.53 | 18.54 | 22.29 | 24.19 | 25.53 | 23.37 | 34.66 |
| 400 | 18.34 | 18.67 | 18.67 | 22.38 | 24.16 | 25.36 | 23.19 | 33.78 |
| 500 | 18.36 | 18.67 | 18.65 | 22.30 | 23.95 | 25.05 | 22.91 | 32.63 |
| 600 | 18.49 | 18.77 | 18.71 | 22.30 | 23.78 | 24.73 | 22.61 | 31.40 |
| 700 | 18.62 | 18.84 | 18.75 | 22.24 | 23.52 | 24.31 | 22.25 | 29.99 |
| 800 | 18.70 | 18.86 | 18.74 | 22.08 | 23.16 | 23.85 | 21.85 | 28.61 |
| 900 | 18.51 | 18.65 | 18.51 | 21.64 | 22.59 | 23.27 | 21.44 | 27.30 |
| 1000 | 18.25 | 18.35 | 18.21 | 21.12 | 21.98 | 22.71 | 21.07 | 26.10 |
| 1100 | 17.95 | 18.03 | 17.90 | 20.59 | 21.40 | 22.25 | 20.80 | 25.08 |
| 1200 | 17.61 | 17.68 | 17.58 | 20.04 | 20.83 | 21.85 | 20.65 | 24.15 |
| 1300 | 17.12 | 17.21 | 17.15 | 19.39 | 20.23 | 21.50 | 20.62 | 23.32 |
| 1400 | 16.59 | 16.71 | 16.70 | 18.73 | 19.62 | 21.20 | 20.69 | 22.54 |
| 1500 | 16.05 | 16.20 | 16.24 | 18.09 | 19.05 | 20.91 | 20.87 | 21.82 |
| 1600 | 15.54 | 15.72 | 15.81 | 17.50 | 18.54 | 20.72 | 21.22 | 21.19 |
| 1700 | 15.09 | 15.31 | 15.45 | 17.02 | 18.12 | 20.61 | 21.71 | 20.64 |
| 1800 | 14.74 | 14.99 | 15.17 | 16.65 | 17.81 | 20.62 | 22.44 | 20.18 |
| 1900 | 14.51 | 14.79 | 15.01 | 16.39 | 17.59 | 20.70 | 23.34 | 19.74 |
| 2000 | 14.40 | 14.72 | 14.97 | 16.28 | 17.51 | 20.89 | 24.45 | 19.38 |
| 2100 | 14.44 | 14.79 | 15.07 | 16.34 | 17.59 | 21.21 | 25.78 | 19.08 |
| 2200 | 14.69 | 15.08 | 15.40 | 16.63 | 17.87 | 21.68 | 27.08 | 18.84 |
| 2300 | 15.21 | 15.63 | 15.98 | 17.20 | 18.39 | 22.31 | 28.02 | 18.67 |
| 2400 | 15.92 | 16.39 | 16.78 | 17.99 | 19.10 | 23.00 | 27.90 | 18.58 |
| 2500 | 16.87 | 17.40 | 17.84 | 19.12 | 20.12 | 23.78 | 26.82 | 18.59 |
| 2600 | 18.07 | 18.71 | 19.22 | 20.72 | 21.51 | 24.46 | 25.20 | 18.63 |
| 2700 | 19.48 | 20.29 | 20.92 | 23.03 | 23.44 | 25.01 | 23.68 | 18.81 |
| 2800 | 20.96 | 22.04 | 22.86 | 26.40 | 25.92 | 25.01 | 22.28 | 19.06 |
| 2900 | 21.77 | 23.10 | 24.08 | 31.40 | 29.02 | 24.68 | 21.17 | 19.46 |
| 3000 | 21.56 | 22.95 | 23.88 | 40.19 | 33.02 | 24.12 | 20.25 | 20.02 |
| 3200 | 19.37 | 20.43 | 20.97 | 28.86 | 32.60 | 23.13 | 19.20 | 21.82 |
| 3400 | 17.69 | 18.49 | 18.82 | 24.08 | 27.23 | 22.34 | 18.73 | 25.01 |
| 3600 | 17.02 | 17.67 | 17.87 | 22.48 | 25.20 | 22.60 | 19.19 | 31.52 |
| 3800 | 17.45 | 17.95 | 18.00 | 22.53 | 24.69 | 24.14 | 20.72 | 37.76 |
| 4000 | 18.23 | 18.53 | 18.47 | 22.43 | 23.78 | 27.27 | 24.11 | 26.48 |
| 4200 | 18.75 | 18.87 | 18.82 | 21.39 | 22.10 | 30.47 | 31.70 | 21.46 |
| 4400 | 19.35 | 19.37 | 19.40 | 20.34 | 20.63 | 27.36 | 29.27 | 18.44 |
| 4600 | 20.65 | 20.63 | 20.76 | 19.74 | 19.57 | 22.63 | 21.44 | 16.44 |
| 4800 | 23.29 | 23.07 | 23.15 | 19.79 | 19.03 | 19.38 | 17.40 | 15.22 |
| 5000 | 28.07 | 26.62 | 26.00 | 19.76 | 18.44 | 16.85 | 14.70 | 14.50 |



REV. B
DAT-31R5A-PP+
6/13/2016

P.O. Box 350166, Brooklyn, New York 11235-0003 (718) 934-4500 • Fax (718) 332-4661 For detailed performance specs & shopping online see Mini-Circuits web site
The Design Engineers Search Engine Provides ACTUAL Data Instantly From MINI-CIRCUITS At: www.minicircuits.com



Digital Step Attenuator

DAT-31R5A-PP+

Typical Performance Data

TEST CONDITIONS: INPUT POWER=0 dBm, Vdd=+3V, TEMPERATURE=+105°C

| FREQUENCY (MHz) | STEP ATTENUATION* AT TTL CONTROL STATE (dB) | | | | | | | |
|--------------------|--|------------------|------------------|------------------|------------------|------------------|-----------------|-------------------|
| | 000000 THRU LOSS | 000001 0.5 dB | 000010 1.0 dB | 000100 2.0 dB | 001000 4.0 dB | 010000 8.0 dB | 100000 16 dB | 111111 31.5 dB |
| 0.1 | 1.30 | 0.51 | 1.00 | 1.98 | 3.97 | 7.87 | 15.81 | 31.15 |
| 0.3 | 1.28 | 0.51 | 1.00 | 1.98 | 3.97 | 7.88 | 15.82 | 31.17 |
| 0.5 | 1.28 | 0.51 | 1.00 | 1.98 | 3.97 | 7.88 | 15.82 | 31.14 |
| 1 | 1.29 | 0.51 | 1.00 | 1.98 | 3.97 | 7.87 | 15.81 | 31.16 |
| 5 | 1.31 | 0.51 | 0.99 | 1.98 | 3.96 | 7.87 | 15.81 | 31.16 |
| 10 | 1.31 | 0.51 | 1.00 | 1.98 | 3.97 | 7.87 | 15.81 | 31.15 |
| 50 | 1.32 | 0.51 | 1.00 | 1.98 | 3.97 | 7.87 | 15.81 | 31.15 |
| 100 | 1.30 | 0.51 | 1.00 | 1.98 | 3.97 | 7.87 | 15.81 | 31.16 |
| 200 | 1.31 | 0.51 | 1.00 | 1.98 | 3.96 | 7.87 | 15.81 | 31.16 |
| 300 | 1.33 | 0.51 | 0.99 | 1.98 | 3.96 | 7.87 | 15.81 | 31.14 |
| 400 | 1.35 | 0.51 | 0.99 | 1.98 | 3.96 | 7.87 | 15.81 | 31.13 |
| 500 | 1.37 | 0.50 | 0.99 | 1.98 | 3.96 | 7.88 | 15.82 | 31.13 |
| 600 | 1.39 | 0.50 | 0.99 | 1.98 | 3.96 | 7.88 | 15.83 | 31.12 |
| 700 | 1.41 | 0.50 | 0.99 | 1.98 | 3.97 | 7.89 | 15.83 | 31.10 |
| 800 | 1.44 | 0.50 | 0.99 | 1.98 | 3.97 | 7.89 | 15.83 | 31.04 |
| 900 | 1.46 | 0.50 | 0.99 | 1.98 | 3.97 | 7.90 | 15.84 | 31.04 |
| 1000 | 1.49 | 0.50 | 0.99 | 1.98 | 3.97 | 7.90 | 15.84 | 31.04 |
| 1100 | 1.51 | 0.51 | 0.99 | 1.98 | 3.97 | 7.90 | 15.84 | 31.03 |
| 1200 | 1.54 | 0.51 | 0.99 | 1.98 | 3.96 | 7.90 | 15.85 | 31.13 |
| 1300 | 1.57 | 0.50 | 0.99 | 1.98 | 3.96 | 7.89 | 15.84 | 31.10 |
| 1400 | 1.59 | 0.50 | 0.99 | 1.97 | 3.95 | 7.89 | 15.86 | 31.19 |
| 1500 | 1.62 | 0.50 | 0.99 | 1.97 | 3.95 | 7.89 | 15.86 | 31.22 |
| 1600 | 1.65 | 0.51 | 0.99 | 1.97 | 3.95 | 7.89 | 15.88 | 31.32 |
| 1700 | 1.67 | 0.51 | 0.99 | 1.98 | 3.94 | 7.90 | 15.90 | 31.38 |
| 1800 | 1.70 | 0.51 | 0.99 | 1.98 | 3.95 | 7.91 | 15.92 | 31.43 |
| 1900 | 1.72 | 0.51 | 1.00 | 1.98 | 3.95 | 7.93 | 15.96 | 31.51 |
| 2000 | 1.73 | 0.51 | 1.00 | 1.99 | 3.96 | 7.94 | 15.99 | 31.47 |
| 2100 | 1.75 | 0.52 | 1.01 | 2.00 | 3.97 | 7.97 | 16.04 | 31.50 |
| 2200 | 1.77 | 0.52 | 1.01 | 2.01 | 3.98 | 8.01 | 16.10 | 31.59 |
| 2300 | 1.78 | 0.52 | 1.02 | 2.02 | 4.00 | 8.05 | 16.17 | 31.63 |
| 2400 | 1.79 | 0.53 | 1.02 | 2.03 | 4.02 | 8.10 | 16.26 | 31.73 |
| 2500 | 1.80 | 0.53 | 1.03 | 2.04 | 4.03 | 8.15 | 16.34 | 31.90 |
| 2600 | 1.82 | 0.53 | 1.03 | 2.04 | 4.05 | 8.20 | 16.42 | 31.74 |
| 2700 | 1.84 | 0.53 | 1.03 | 2.05 | 4.06 | 8.25 | 16.53 | 32.06 |
| 2800 | 1.86 | 0.53 | 1.03 | 2.05 | 4.06 | 8.28 | 16.58 | 31.95 |
| 2900 | 1.87 | 0.53 | 1.03 | 2.04 | 4.06 | 8.31 | 16.64 | 31.92 |
| 3000 | 1.87 | 0.53 | 1.02 | 2.04 | 4.05 | 8.33 | 16.70 | 32.10 |
| 3200 | 1.85 | 0.52 | 1.00 | 2.01 | 4.02 | 8.34 | 16.75 | 31.73 |
| 3400 | 1.90 | 0.51 | 0.99 | 1.99 | 3.99 | 8.34 | 16.76 | 31.52 |
| 3600 | 1.96 | 0.50 | 0.98 | 1.98 | 3.98 | 8.37 | 16.84 | 31.76 |
| 3800 | 2.04 | 0.50 | 0.97 | 1.98 | 3.98 | 8.38 | 16.85 | 31.53 |
| 4000 | 2.12 | 0.51 | 0.98 | 2.00 | 3.99 | 8.41 | 16.92 | 31.89 |
| 4200 | 2.18 | 0.51 | 0.98 | 2.01 | 3.99 | 8.45 | 17.03 | 32.39 |
| 4400 | 2.24 | 0.49 | 0.97 | 2.01 | 4.00 | 8.52 | 17.27 | 33.51 |
| 4600 | 2.28 | 0.50 | 0.99 | 2.04 | 4.04 | 8.66 | 17.67 | 34.56 |
| 4800 | 2.31 | 0.54 | 1.03 | 2.11 | 4.14 | 8.90 | 18.17 | 35.25 |
| 5000 | 2.39 | 0.55 | 1.03 | 2.16 | 4.22 | 9.17 | 18.72 | 33.76 |

* Step Attenuation above Thru Loss (TTL Logic 00000).



REV. B
DAT-31R5A-PP+
6/13/2016

P.O. Box 350166, Brooklyn, New York 11235-0003 (718) 934-4500 • Fax (718) 332-4661 For detailed performance specs & shopping online see Mini-Circuits web site
The Design Engineers Search Engine Provides ACTUAL Data Instantly From MINI-CIRCUITS At: www.minicircuits.com



IF/RF MICROWAVE COMPONENTS

Digital Step Attenuator

DAT-31R5A-PP+

Typical Performance Data

TEST CONDITIONS: INPUT POWER=0 dBm, Vdd=+3V, TEMPERATURE=+105°C

| FREQUENCY (MHz) | INPUT RETURN LOSS AT TTL CONTROL STATE (dB) | | | | | | | |
|--------------------|--|------------------|------------------|------------------|------------------|------------------|-----------------|-------------------|
| | 000000 0 dB | 000001 0.5 dB | 000010 1.0 dB | 000100 2.0 dB | 001000 4.0 dB | 010000 8.0 dB | 100000 16 dB | 111111 31.5 dB |
| 0.1 | 16.83 | 17.58 | 18.25 | 16.27 | 16.05 | 16.66 | 20.02 | 21.78 |
| 0.3 | 16.97 | 17.70 | 18.36 | 16.37 | 16.14 | 16.73 | 20.04 | 21.79 |
| 0.5 | 16.97 | 17.70 | 18.36 | 16.37 | 16.14 | 16.73 | 20.04 | 21.76 |
| 1 | 17.03 | 17.77 | 18.43 | 16.41 | 16.17 | 16.74 | 20.05 | 21.77 |
| 5 | 17.02 | 17.77 | 18.42 | 16.41 | 16.17 | 16.75 | 20.07 | 21.80 |
| 10 | 17.03 | 17.78 | 18.43 | 16.42 | 16.17 | 16.75 | 20.06 | 21.80 |
| 50 | 17.11 | 17.86 | 18.53 | 16.52 | 16.28 | 16.88 | 20.23 | 22.00 |
| 100 | 17.40 | 18.20 | 18.90 | 16.84 | 16.62 | 17.27 | 20.80 | 22.70 |
| 200 | 17.20 | 17.99 | 18.69 | 16.72 | 16.54 | 17.20 | 20.62 | 22.50 |
| 300 | 16.82 | 17.53 | 18.15 | 16.27 | 16.01 | 16.53 | 19.48 | 21.12 |
| 400 | 16.95 | 17.60 | 18.17 | 16.21 | 15.84 | 16.21 | 18.91 | 20.45 |
| 500 | 17.10 | 17.71 | 18.25 | 16.21 | 15.77 | 16.05 | 18.59 | 20.08 |
| 600 | 17.10 | 17.68 | 18.18 | 16.11 | 15.62 | 15.84 | 18.22 | 19.66 |
| 700 | 17.05 | 17.59 | 18.05 | 15.97 | 15.43 | 15.59 | 17.84 | 19.19 |
| 800 | 17.09 | 17.58 | 17.98 | 15.88 | 15.29 | 15.39 | 17.52 | 18.77 |
| 900 | 16.95 | 17.40 | 17.75 | 15.72 | 15.12 | 15.21 | 17.26 | 18.40 |
| 1000 | 16.74 | 17.14 | 17.46 | 15.56 | 14.99 | 15.09 | 17.10 | 18.16 |
| 1100 | 16.51 | 16.89 | 17.18 | 15.47 | 14.95 | 15.12 | 17.14 | 18.11 |
| 1200 | 16.19 | 16.52 | 16.79 | 15.32 | 14.89 | 15.14 | 17.21 | 18.04 |
| 1300 | 15.61 | 15.92 | 16.18 | 15.00 | 14.72 | 15.10 | 17.22 | 17.89 |
| 1400 | 15.12 | 15.44 | 15.69 | 14.77 | 14.63 | 15.16 | 17.36 | 17.88 |
| 1500 | 14.73 | 15.05 | 15.30 | 14.63 | 14.64 | 15.36 | 17.71 | 18.06 |
| 1600 | 14.40 | 14.72 | 14.98 | 14.52 | 14.70 | 15.62 | 18.13 | 18.28 |
| 1700 | 14.09 | 14.41 | 14.67 | 14.42 | 14.76 | 15.91 | 18.62 | 18.49 |
| 1800 | 13.86 | 14.19 | 14.44 | 14.38 | 14.87 | 16.27 | 19.20 | 18.75 |
| 1900 | 13.73 | 14.06 | 14.31 | 14.41 | 15.05 | 16.73 | 19.93 | 19.09 |
| 2000 | 13.76 | 14.09 | 14.33 | 14.59 | 15.38 | 17.38 | 20.90 | 19.49 |
| 2100 | 13.82 | 14.16 | 14.39 | 14.79 | 15.73 | 18.07 | 21.90 | 19.80 |
| 2200 | 14.14 | 14.49 | 14.69 | 15.23 | 16.30 | 19.03 | 23.18 | 20.20 |
| 2300 | 14.69 | 15.05 | 15.23 | 15.88 | 17.10 | 20.31 | 24.82 | 20.74 |
| 2400 | 15.42 | 15.79 | 15.94 | 16.72 | 18.11 | 21.93 | 26.51 | 21.22 |
| 2500 | 16.39 | 16.77 | 16.87 | 17.80 | 19.35 | 23.94 | 27.50 | 21.49 |
| 2600 | 17.78 | 18.22 | 18.27 | 19.35 | 21.18 | 27.17 | 27.81 | 21.93 |
| 2700 | 19.81 | 20.36 | 20.33 | 21.61 | 23.92 | 32.80 | 26.68 | 22.29 |
| 2800 | 22.35 | 23.30 | 23.23 | 24.66 | 27.99 | 39.80 | 24.70 | 22.37 |
| 2900 | 25.24 | 27.25 | 27.31 | 28.43 | 33.88 | 31.99 | 22.86 | 22.16 |
| 3000 | 26.61 | 30.87 | 33.52 | 30.08 | 33.76 | 27.40 | 21.54 | 22.15 |
| 3200 | 23.25 | 26.08 | 29.72 | 24.60 | 24.86 | 22.25 | 19.39 | 21.77 |
| 3400 | 20.56 | 22.44 | 24.55 | 21.26 | 21.36 | 20.12 | 18.48 | 22.15 |
| 3600 | 19.74 | 21.38 | 23.08 | 19.88 | 19.82 | 19.23 | 18.28 | 23.02 |
| 3800 | 20.93 | 22.56 | 24.01 | 20.38 | 20.17 | 20.06 | 19.47 | 25.80 |
| 4000 | 22.66 | 23.52 | 23.75 | 21.91 | 22.08 | 23.60 | 23.49 | 35.72 |
| 4200 | 20.37 | 20.15 | 19.75 | 21.04 | 22.50 | 29.28 | 36.09 | 28.04 |
| 4400 | 16.70 | 16.46 | 16.10 | 17.92 | 19.41 | 23.30 | 24.85 | 19.87 |
| 4600 | 14.82 | 14.68 | 14.30 | 15.98 | 16.99 | 18.50 | 18.31 | 16.01 |
| 4800 | 14.46 | 14.06 | 13.59 | 15.05 | 15.49 | 15.61 | 14.85 | 13.63 |
| 5000 | 14.98 | 14.32 | 13.75 | 14.88 | 14.73 | 13.90 | 12.82 | 12.21 |



REV. B
DAT-31R5A-PP+
6/13/2016

P.O. Box 350166, Brooklyn, New York 11235-0003 (718) 934-4500 • Fax (718) 332-4661 For detailed performance specs & shopping online see Mini-Circuits web site
The Design Engineers Search Engine Provides ACTUAL Data Instantly From MINI-CIRCUITS At: www.minicircuits.com



IF/RF MICROWAVE COMPONENTS

Digital Step Attenuator

DAT-31R5A-PP+

Typical Performance Data

TEST CONDITIONS: INPUT POWER=0 dBm, Vdd=+3V, TEMPERATURE=+105°C

| FREQUENCY (MHz) | OUTPUT RETURN LOSS AT TTL CONTROL STATE (dB) | | | | | | | |
|--------------------|---|------------------|------------------|------------------|------------------|------------------|-----------------|-------------------|
| | 000000 0 dB | 000001 0.5 dB | 000010 1.0 dB | 000100 2.0 dB | 001000 4.0 dB | 010000 8.0 dB | 100000 16 dB | 111111 31.5 dB |
| 0.1 | 16.62 | 16.69 | 16.46 | 18.93 | 19.46 | 19.36 | 17.65 | 22.37 |
| 0.3 | 16.74 | 16.80 | 16.57 | 19.02 | 19.52 | 19.40 | 17.70 | 22.39 |
| 0.5 | 16.78 | 16.83 | 16.61 | 19.06 | 19.55 | 19.41 | 17.70 | 22.37 |
| 1 | 16.84 | 16.88 | 16.64 | 19.10 | 19.57 | 19.42 | 17.70 | 22.38 |
| 5 | 16.92 | 16.96 | 16.72 | 19.19 | 19.62 | 19.45 | 17.72 | 22.38 |
| 10 | 16.93 | 16.97 | 16.73 | 19.20 | 19.63 | 19.46 | 17.72 | 22.39 |
| 50 | 16.95 | 17.01 | 16.78 | 19.25 | 19.72 | 19.58 | 17.85 | 22.56 |
| 100 | 16.98 | 17.06 | 16.85 | 19.39 | 19.93 | 19.88 | 18.13 | 23.04 |
| 200 | 17.15 | 17.23 | 17.03 | 19.59 | 20.13 | 20.05 | 18.26 | 23.27 |
| 300 | 17.10 | 17.14 | 16.90 | 19.27 | 19.63 | 19.35 | 17.63 | 22.17 |
| 400 | 17.00 | 16.99 | 16.70 | 18.89 | 19.08 | 18.64 | 16.97 | 21.09 |
| 500 | 16.91 | 16.86 | 16.55 | 18.64 | 18.71 | 18.20 | 16.58 | 20.41 |
| 600 | 17.13 | 17.03 | 16.67 | 18.70 | 18.64 | 18.04 | 16.41 | 20.06 |
| 700 | 17.20 | 17.05 | 16.66 | 18.59 | 18.41 | 17.72 | 16.11 | 19.54 |
| 800 | 17.11 | 16.90 | 16.48 | 18.26 | 17.98 | 17.28 | 15.74 | 18.84 |
| 900 | 16.93 | 16.70 | 16.27 | 17.92 | 17.60 | 16.94 | 15.48 | 18.29 |
| 1000 | 16.66 | 16.42 | 16.02 | 17.54 | 17.23 | 16.68 | 15.32 | 17.84 |
| 1100 | 16.26 | 16.05 | 15.69 | 17.10 | 16.87 | 16.48 | 15.25 | 17.51 |
| 1200 | 15.77 | 15.60 | 15.31 | 16.61 | 16.51 | 16.33 | 15.26 | 17.23 |
| 1300 | 15.33 | 15.20 | 14.99 | 16.19 | 16.21 | 16.26 | 15.35 | 17.01 |
| 1400 | 14.89 | 14.82 | 14.68 | 15.79 | 15.94 | 16.24 | 15.54 | 16.85 |
| 1500 | 14.46 | 14.44 | 14.36 | 15.41 | 15.69 | 16.27 | 15.82 | 16.75 |
| 1600 | 14.12 | 14.16 | 14.14 | 15.13 | 15.54 | 16.42 | 16.23 | 16.74 |
| 1700 | 13.83 | 13.90 | 13.94 | 14.89 | 15.42 | 16.60 | 16.73 | 16.77 |
| 1800 | 13.64 | 13.75 | 13.84 | 14.74 | 15.38 | 16.89 | 17.38 | 16.84 |
| 1900 | 13.57 | 13.72 | 13.85 | 14.70 | 15.42 | 17.27 | 18.19 | 16.94 |
| 2000 | 13.55 | 13.72 | 13.90 | 14.71 | 15.51 | 17.73 | 19.18 | 17.10 |
| 2100 | 13.69 | 13.90 | 14.10 | 14.88 | 15.76 | 18.38 | 20.50 | 17.35 |
| 2200 | 13.99 | 14.22 | 14.46 | 15.20 | 16.12 | 19.19 | 22.18 | 17.63 |
| 2300 | 14.53 | 14.79 | 15.05 | 15.76 | 16.74 | 20.34 | 24.58 | 18.05 |
| 2400 | 15.26 | 15.56 | 15.84 | 16.54 | 17.55 | 21.83 | 28.10 | 18.59 |
| 2500 | 16.20 | 16.54 | 16.84 | 17.60 | 18.68 | 23.89 | 34.49 | 19.31 |
| 2600 | 17.42 | 17.79 | 18.13 | 19.02 | 20.16 | 26.75 | 53.77 | 20.17 |
| 2700 | 18.66 | 19.11 | 19.46 | 20.67 | 21.88 | 30.67 | 33.50 | 21.02 |
| 2800 | 19.91 | 20.46 | 20.82 | 22.98 | 24.41 | 38.46 | 27.93 | 22.15 |
| 2900 | 20.48 | 21.14 | 21.50 | 25.37 | 27.46 | 39.86 | 24.79 | 23.54 |
| 3000 | 20.51 | 21.21 | 21.53 | 27.62 | 31.29 | 31.67 | 22.61 | 25.36 |
| 3200 | 18.97 | 19.55 | 19.74 | 25.99 | 29.27 | 25.16 | 20.03 | 30.93 |
| 3400 | 17.22 | 17.66 | 17.76 | 22.31 | 23.94 | 21.89 | 18.51 | 51.21 |
| 3600 | 16.74 | 17.03 | 17.00 | 20.75 | 21.58 | 20.67 | 18.21 | 29.50 |
| 3800 | 17.09 | 17.21 | 17.06 | 20.14 | 20.37 | 20.60 | 19.01 | 23.88 |
| 4000 | 17.56 | 17.49 | 17.28 | 19.31 | 19.28 | 21.16 | 21.03 | 20.56 |
| 4200 | 17.54 | 17.41 | 17.29 | 18.19 | 18.27 | 22.07 | 25.37 | 18.44 |
| 4400 | 17.57 | 17.42 | 17.46 | 17.33 | 17.57 | 22.89 | 37.52 | 16.94 |
| 4600 | 18.16 | 18.10 | 18.30 | 17.08 | 17.34 | 22.60 | 26.44 | 15.90 |
| 4800 | 20.02 | 20.12 | 20.37 | 17.69 | 17.75 | 21.05 | 19.92 | 15.34 |
| 5000 | 24.06 | 23.87 | 23.95 | 18.74 | 18.36 | 18.67 | 16.18 | 15.16 |



REV. B
DAT-31R5A-PP+
6/13/2016

P.O. Box 350166, Brooklyn, New York 11235-0003 (718) 934-4500 • Fax (718) 332-4661 For detailed performance specs & shopping online see Mini-Circuits web site
The Design Engineers Search Engine Provides ACTUAL Data Instantly From MINI-CIRCUITS At: www.minicircuits.com

Digital Step Attenuator

Typical Performance Curves

DAT-31R5A-PP+

Thru Loss

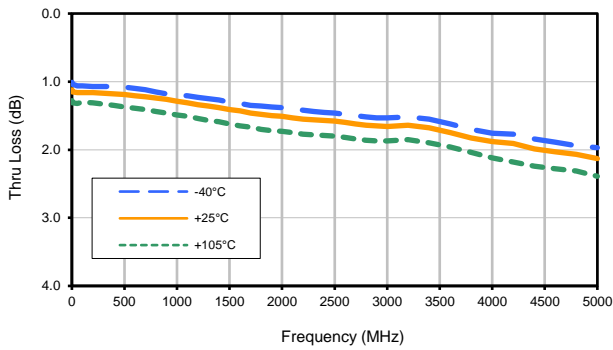

Step Attenuation (0.5dB)

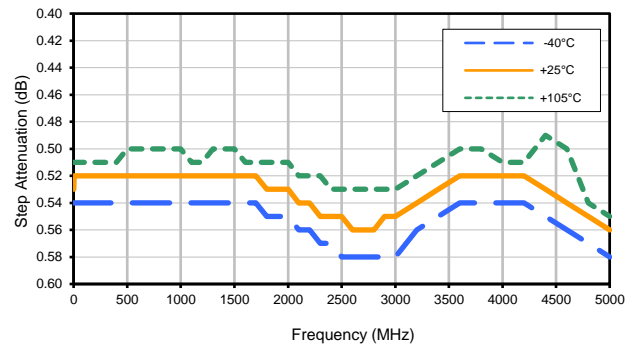

Step Attenuation (1dB)

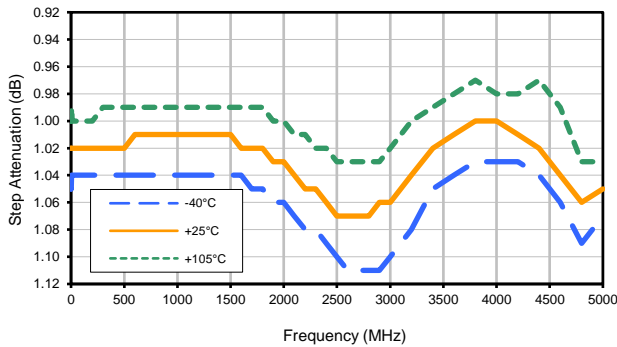

Step Attenuation (2dB)

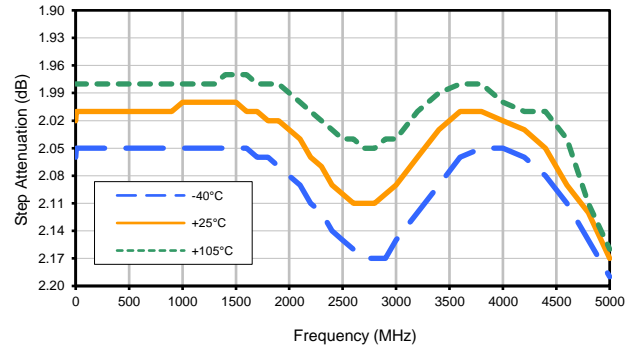

Step Attenuation (4dB)

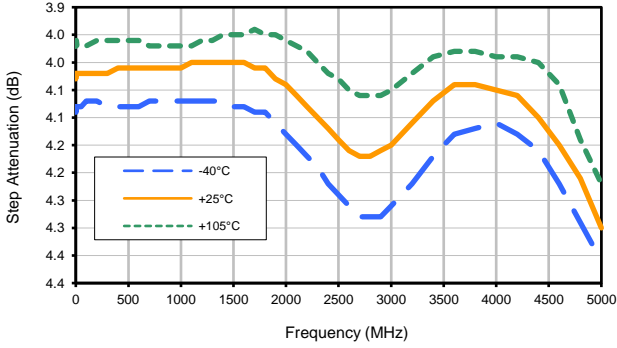

Step Attenuation (8dB)

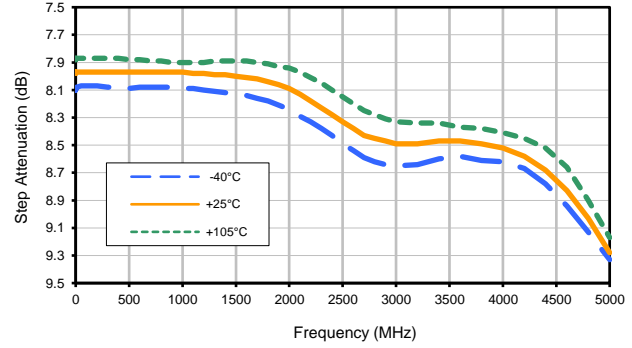

Step Attenuation (16dB)

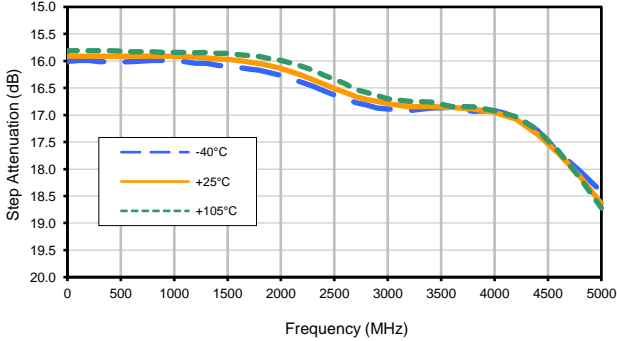

Step Attenuation (31.5dB)

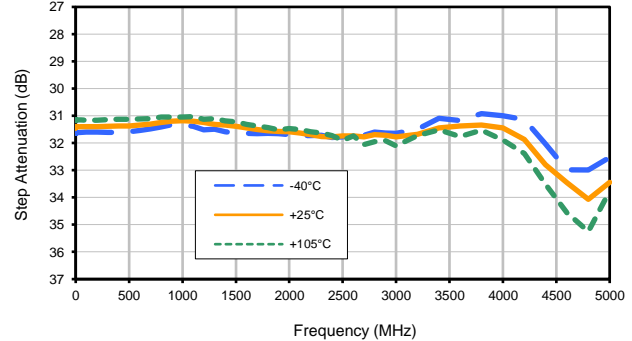

Digital Step Attenuator

Typical Performance Curves

DAT-31R5A-PP+

Input Return Loss (0dB)

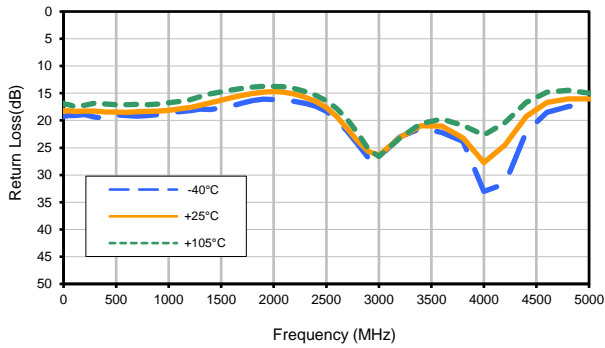

Input Return Loss (0.5dB)

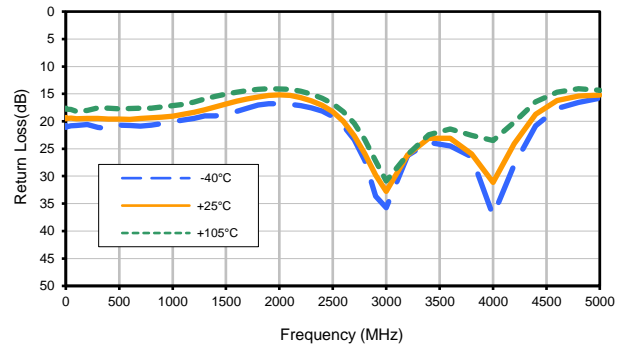

Input Return Loss (1dB)

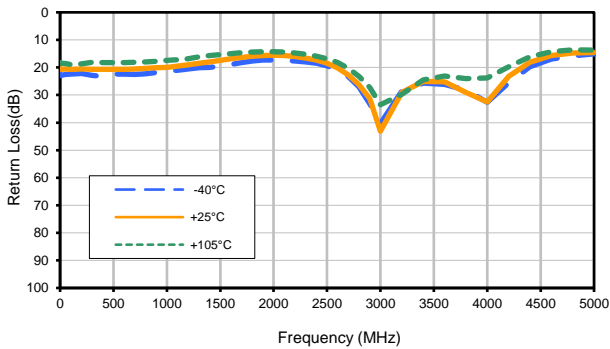

Input Return Loss(2dB)

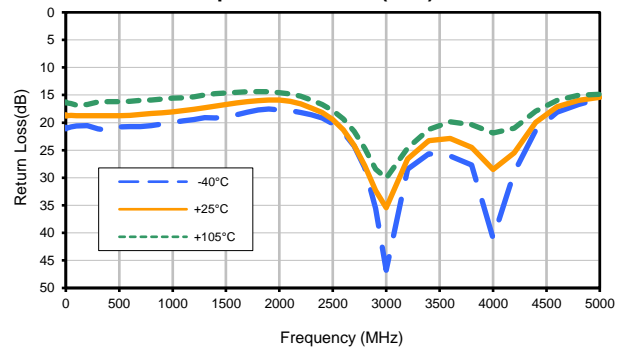

Input Return Loss (4dB)

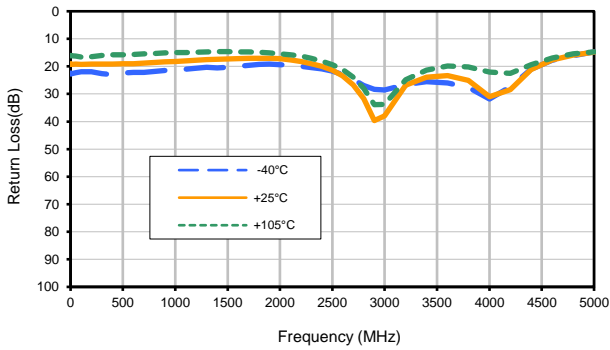

Input Return Loss (8dB)

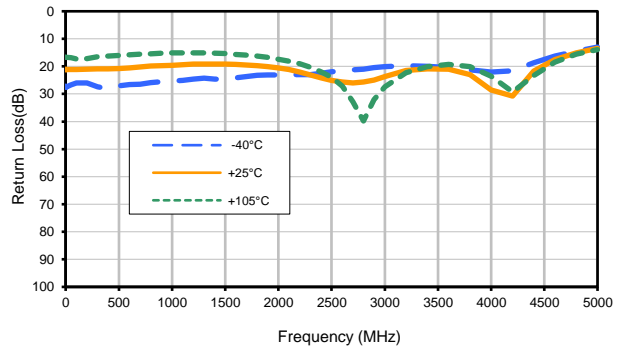

Input Return Loss (16dB)

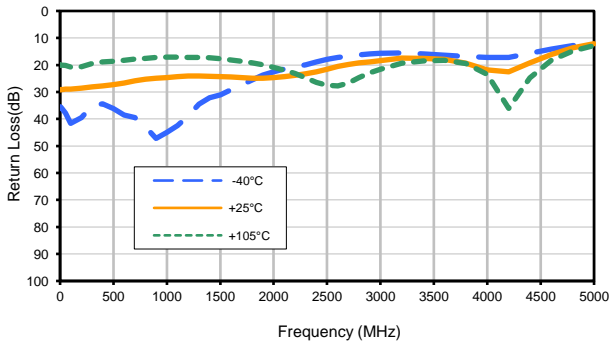

Input Return Loss (31.5dB)

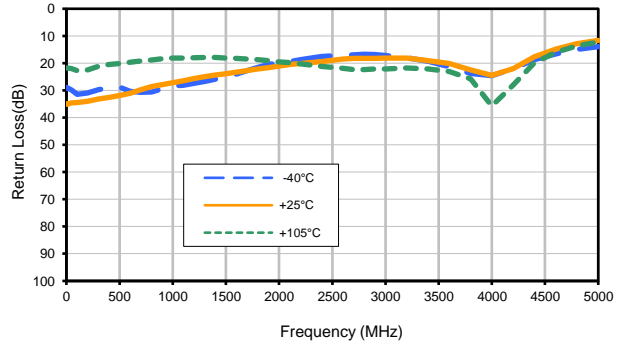

Digital Step Attenuator

Typical Performance Curves

DAT-31R5A-PP+

Output Return Loss (0dB)

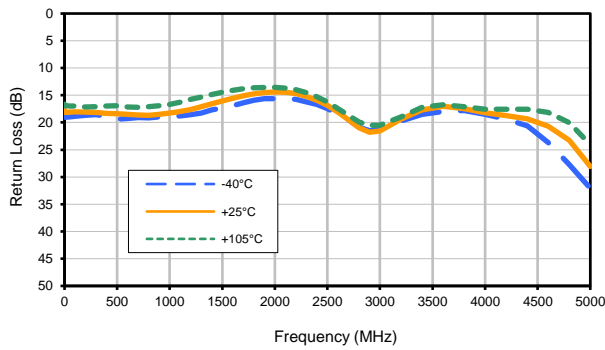

Output Return Loss (0.5dB)

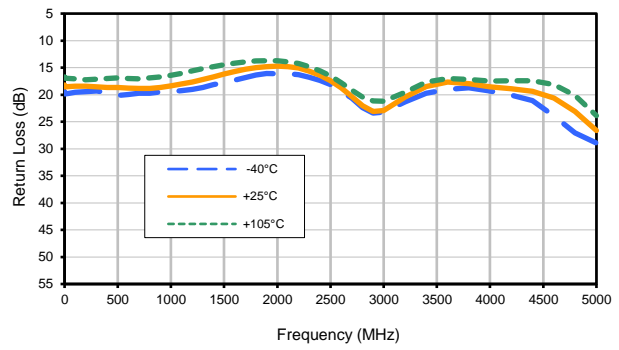

Output Return Loss (1dB)

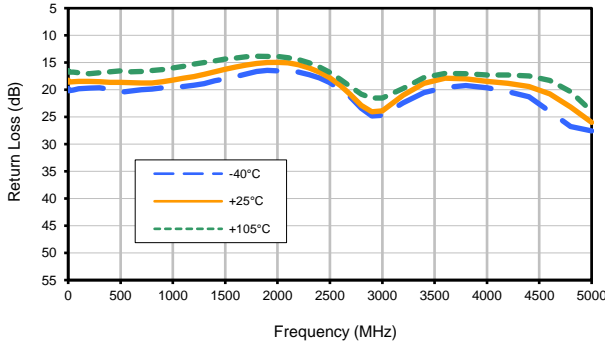

Output Return Loss (2dB)

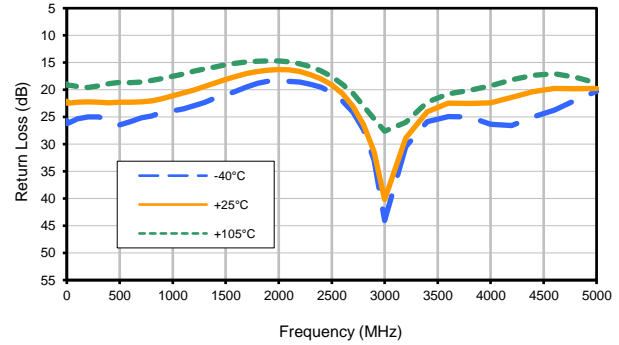

Output Return Loss (4dB)

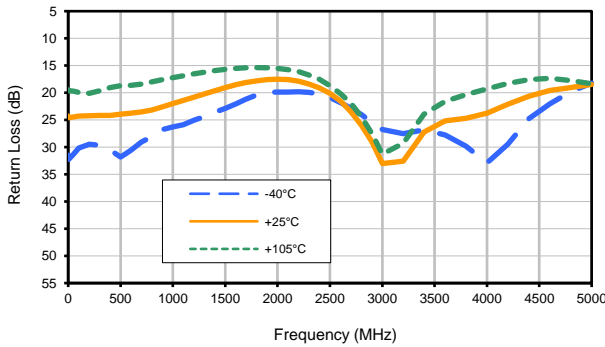

Output Return Loss (8dB)

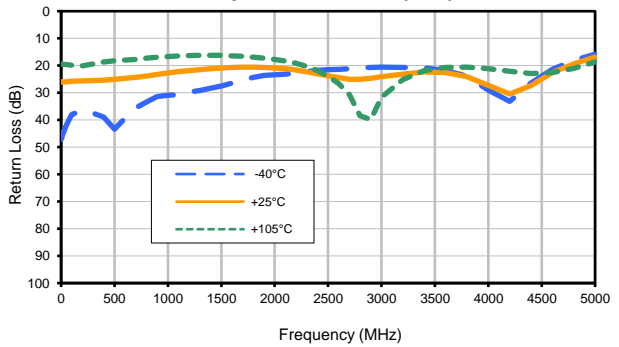

Output Return Loss (16dB)

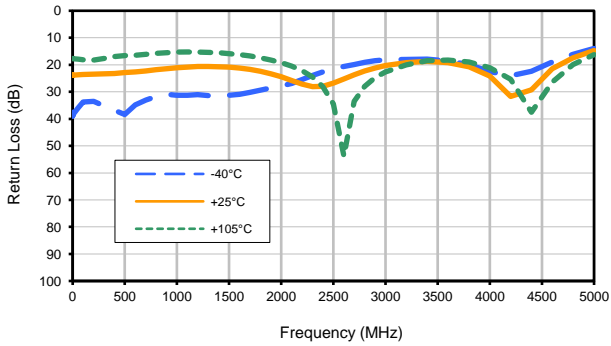

Output Return Loss (31.5dB)

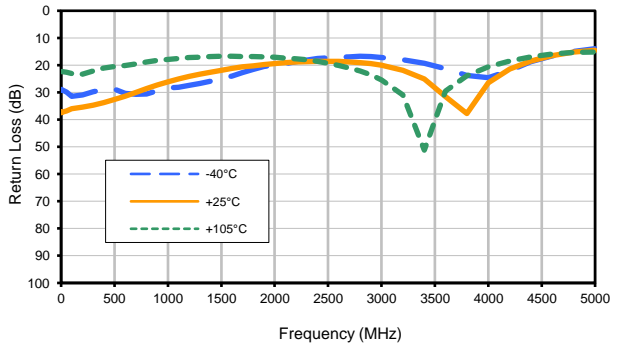

Outline Dimensions

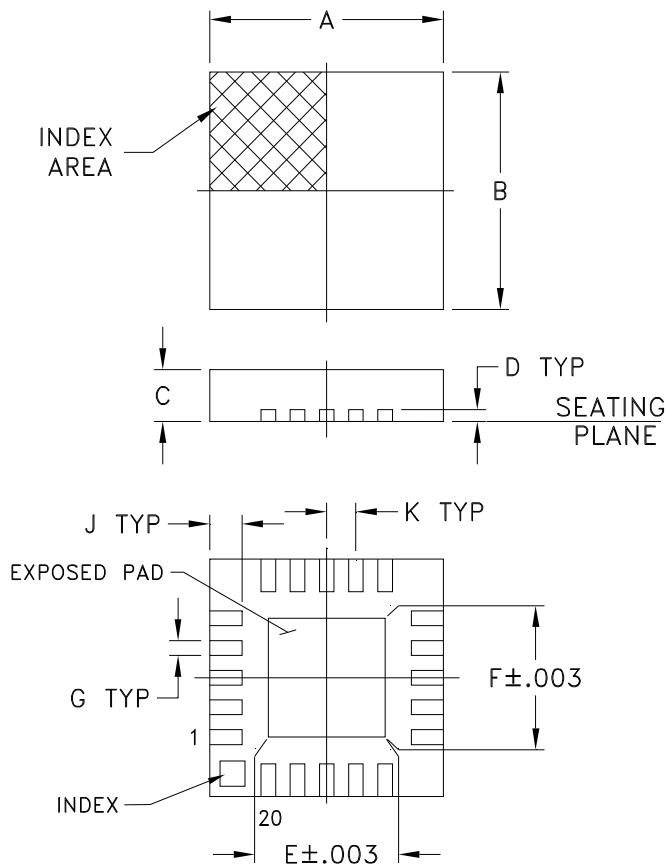

PCB Land Pattern

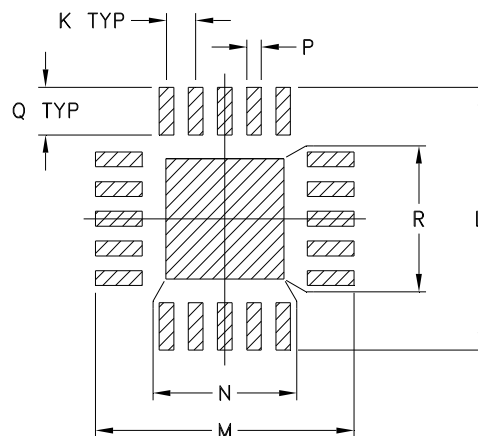

Suggested Layout,
Tolerance to be within $\pm .002$

| CASE # | A | B | C | D | E | F | G | H | J | K |
|---------|----------------|----------------|----------------|----------------|----------------|----------------|----------------|----------|----------------|----------------|
| DG983-2 | .157 (4.00) | .157 (4.00) | .033 (0.85) | .008 (0.20) | .085 (2.15) | .085 (2.15) | .009 (0.23) | -- -- | .022 (0.55) | .020 (0.50) |

| CASE # | L | M | N | P | Q | R | WT. GRAM |
|---------|----------------|----------------|----------------|----------------|----------------|----------------|----------|
| DG983-2 | .177 (4.50) | .177 (4.50) | .081 (2.06) | .010 (0.25) | .032 (0.81) | .081 (2.06) | .04 |

Dimensions are in inches (mm). Tolerances: 2 Pl. $\pm .01$; 3 Pl. $\pm .005$

Notes:

1. Case material: Plastic.
2. Termination finish:

For RoHS Case Styles: 0.2 μ inches of Gold (Au) over 0.1 μ inches of Palladium (Pd) over 10 μ inches of Nickel (Ni). All models, (+) suffix.

For RoHS-5 Case Styles: Tin-Lead plate. All models, no (+) suffix.

Tape & Reel Packaging TR-F87

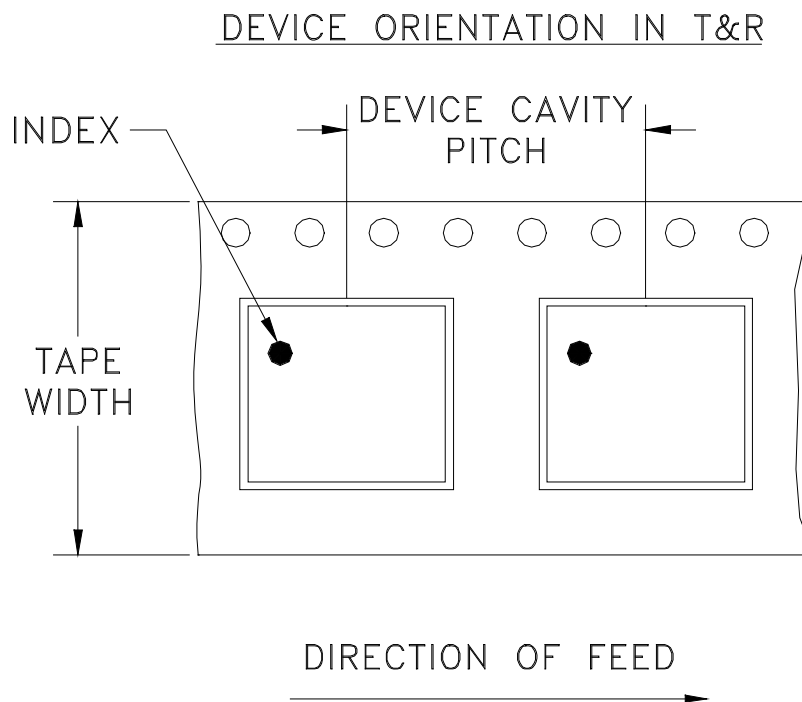

| Tape Width, mm | Device Cavity Pitch, mm | Reel Size, inches | Devices per Reel | |
|----------------|-------------------------|-------------------|-------------------------------------|------|
| 12 | 8 | 7 | Small quantity standards (see note) | 20 |
| | | | | 50 |
| | | | | 100 |
| | | | | 200 |
| | | | | 500 |
| | | 1000 | | |
| | | 13 | Standard | 3000 |

Note : Please Consult individual model data sheet to determine device per reel availability

Mini-Circuits carrier tape materials provide protection from ESD (Electro-Static Discharge) during handling and transportation. Tapes are static dissipative and comply with industry standards EIA-481/EIA-541.

Go to: www.minicircuits.com/pages/pdfs/tape.pdf

Mini-Circuits[®]

INTERNET <http://www.minicircuits.com>

P.O. Box 350166, Brooklyn, New York 11235-0003 (718) 934-4500 Fax (718) 332-4661

Distribution Centers NORTH AMERICA 800-654-7949 • 417-335-5935 • Fax 417-335-5945 • EUROPE 44-1252-832600 • Fax 44-1252-837010

Mini-Circuits ISO 9001 & ISO 14001 Certified

THIRD ANGLE PROJECTION

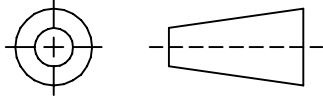

REVISIONS

| REV | ECN No. | DESCRIPTION | DATE | DR | AUTH |
|-----|---------|---|-------|----|------|
| OR | M96972 | NEW RELEASE (FROM RAVON) | 03/05 | DK | HH |
| A | M102713 | MODIFIED HATCH, NOTES & ADDED "...WITH SMOBC" | 01/06 | GT | IL |
| B | M103510 | ADD R7 & CHANGE LOCATION DESIGNATORS | 07/09 | EM | KN |
| B | R63339 | ADD R7 & CHANGE LOCATION DESIGNATORS | 07/09 | EM | KN |

SUGGESTED MOUNTING CONFIGURATION

FOR DG983-1 CASE STYLE, qp PIN CONNECTIONS, 50 Ω.

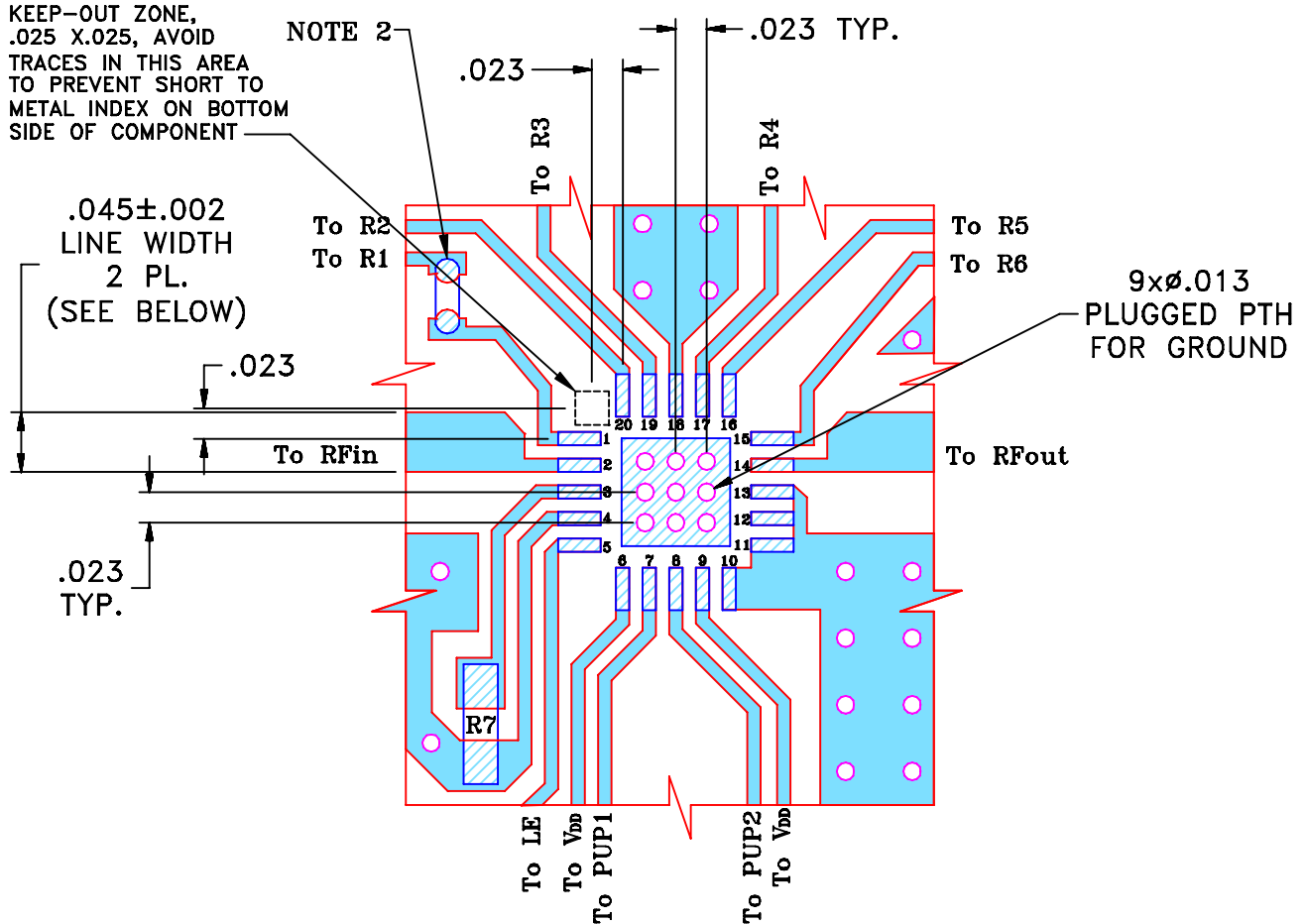

NOTES:

1. TRACE WIDTH IS SHOWN FOR FR4 WITH DIELECTRIC THICKNESS. .025"±.002". COPPER: 1/2 OZ. EACH SIDE. FOR OTHER MATERIALS TRACE WIDTH MAY NEED TO BE MODIFIED.
2. 0603, 0402 SIZES CHIP FOOT PRINTS SHOWN FOR REFERENCE, VALUES OF RESISTORS WILL VARY BASED ON APPLICATION.
3. BOTTOM SIDE OF THE PCB IS CONTINUOUS GROUND PLANE.

- DENOTES PCB COPPER LAYOUT WITH SMOBC (SOLDER MASK OVER BARE COPPER)
- DENOTES COPPER LAND PATTERN FREE OF SOLDER MASK

| UNLESS OTHERWISE SPECIFIED | INITIALS | | DATE |
|----------------------------|----------|------------|-----------|
| DIMENSIONS ARE IN INCHES | DRAWN | DK (RAVON) | 08 MAR 05 |
| TOLERANCES ON: | CHECKED | RZ (RAVON) | 08 MAR 05 |
| 2 PL DECIMALS ± | APPROVED | HH (RAVON) | 08 MAR 05 |
| 3 PL DECIMALS ± .005 | | | |
| ANGLES ± | | | |
| FRACTIONS ± | | | |

Mini-Circuits® 13 Neptune Avenue
Brooklyn NY 11235

PL, qp, DG983-1
TB-339 (50 Ω)

| SIZE | CODE IDENT | DRAWING NO: | REV: |
|-------|------------|-------------|--------|
| A | 15542 | 98-PL-180 | B |
| FILE: | 98PL180 | SCALE: | 7:1 |
| | | SHEET: | 1 OF 1 |

Mini-Circuits®
THIS DOCUMENT AND ITS CONTENTS ARE THE PROPERTY OF MINI-CIRCUITS. EXCEPT FOR USE EXPRESSLY GRANTED, IN WRITING, TO ITS VENDORS, VENDEE AND THE UNITED STATES GOVERNMENT, MINI-CIRCUITS RESERVES ALL PROPRIETARY DESIGN, USE, MANUFACTURING AND REPRODUCTION RIGHTS THERETO. THESE CONTENTS SHALL NOT BE USED, DUPLICATED OR DISCLOSED TO ANY OUTSIDE PARTY, IN WHOLE OR IN PART, WITHOUT WRITTEN PERMISSION OF MINI-CIRCUITS.

Evaluation Board and Circuit

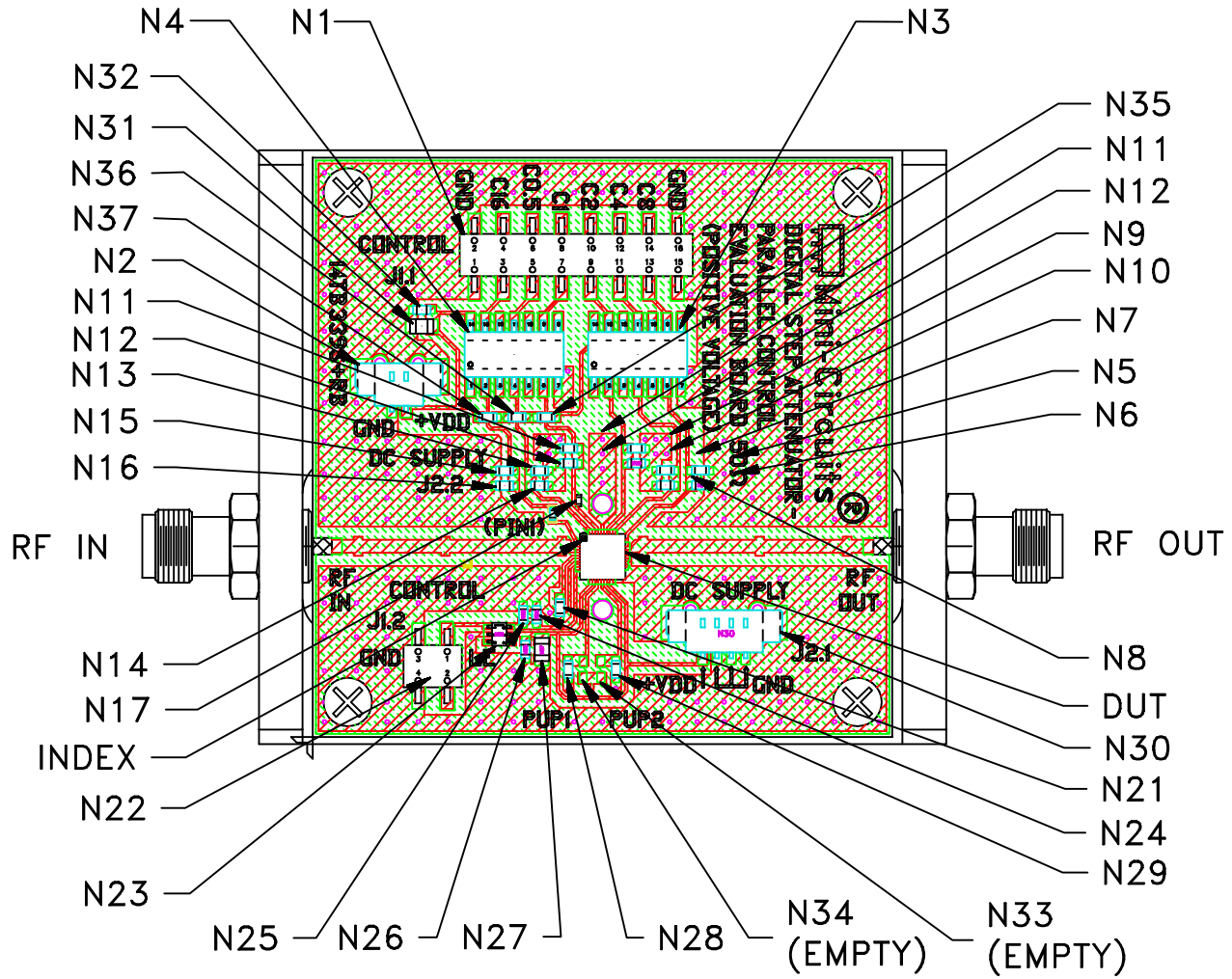

TB-339

Notes:

1. N-Type Female connectors.
2. PCB Material: FR4 Grade IT 180TC (ITEQ Corporation) or equivalent, Dielectric Constant=4.7, Thickness=.025 inch.



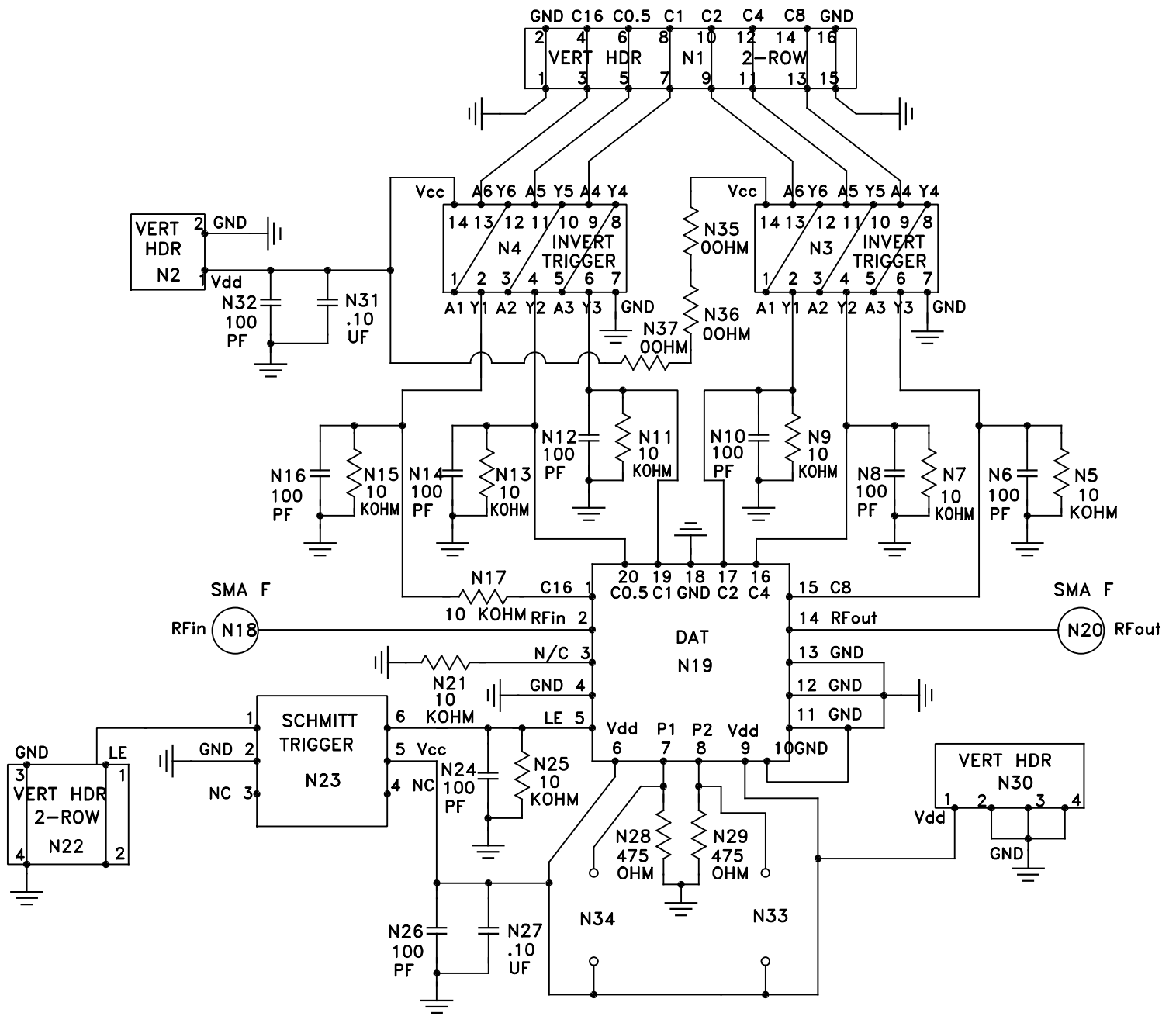

Schematic Diagram

All Mini-Circuits products are manufactured under exacting quality assurance and control standards, and are capable of meeting published specifications after being subjected to any or all of the following physical and environmental test.

| Specification | Test/Inspection Condition | Reference/Spec |
|--------------------------------|---|---|
| Operating Temperature | -40° to 85° C or -40° to 105° C Ambient Environment | Refer to Individual Model Data Sheet |
| Storage Temperature | -55° to 100° C or -65° to 150° C Ambient Environment | Refer to Individual Model Data Sheet |
| Temperature Humidity Bias | 85°C, 85% RH, 96 hours | JESD22-A101B |
| Thermal Shock | -55° to 100°C, 100 cycles | MIL-STD-202, Method 107, Condition A-3, except +100°C |
| Solder Reflow Heat | Pb-Free Process: 260°C peak | J-STD-020, Table 4-1, 4-2 and 5-2; Figure 5-1 |
| Solderability | 10X magnification, 95% coverage | JESD22-B102, Method 1: Dip and Look Test |
| Marking Resistance to Solvents | Laser marked, visual observation | Mini-Circuits D4-Q4T0-04 |