

PART NO.	CARD THICKNESS
RCP-06	1/16 (1.6)
RCP-09	3/32 (2.4)

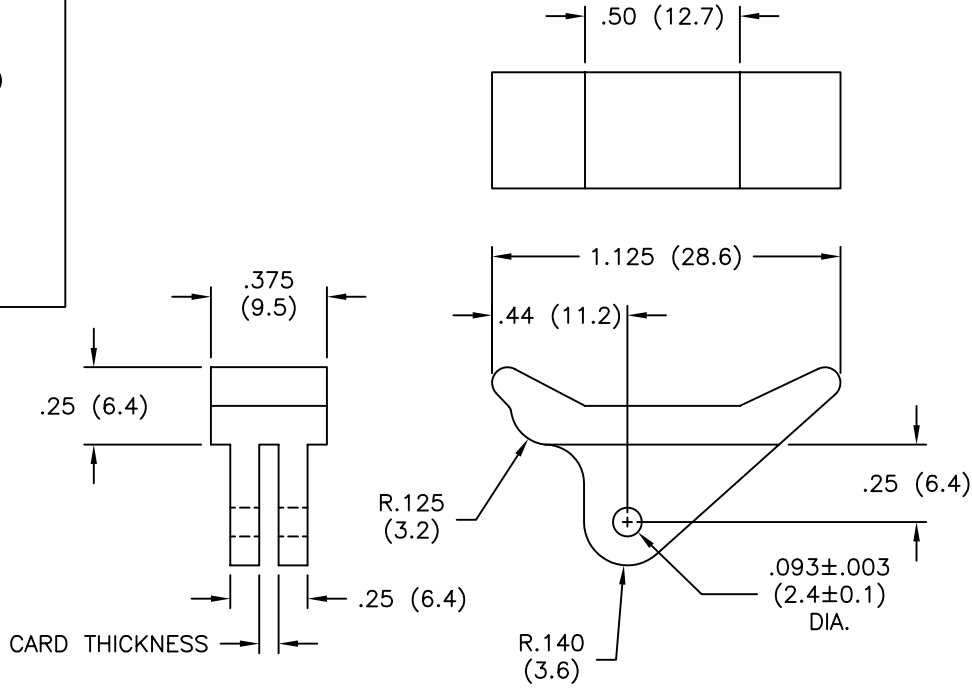
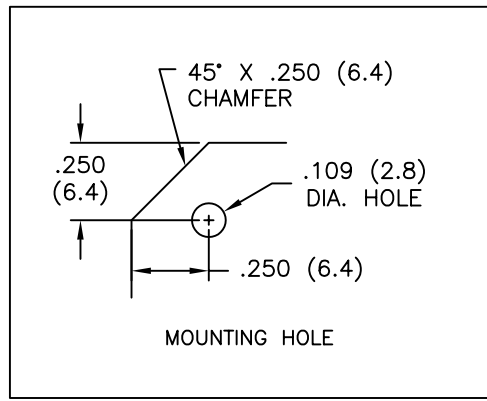

NOTES:

1. MATERIAL: NYLON 6/6 (RMS-48).
2. COLOR: WHITE.
3. INSTALLATION ROLL PIN NO. RRP-250, MATERIAL: PASSIVATED STAINLESS STEEL PER MIL-P-10971. COLOR: SILVER.
 3/32 (2.4) DIA. X 1/4 (6.4) LONG, FURNISHED WITH EJECTORS.

TITLE: CARD EJECTORS		DWG IN IN (MM)		FINAL	
FILE # RCP	DWN: P.B.	APP:	PART #		
MAT'L: SEE NOTES	DT: 04-07-94	DT:	SEE TABLE		
RE: RICHCO, INC.	RICHCO INC. PO BOX 804238, CHICAGO, 60680 (773) 539-4060		PRINT TYPE CA		

REV	DESCRIPTION	ENGR	DATE
D	ADDED MOUNTING HOLE DETAIL, ECN #659	SM	07.02.03
C	ADDED NOTE 3 (ECN #472)	SM	09.26.02
B	CHANGED FILE NUMBER	SM	05.15.01
A	MAT'L COLOR WHITE WAS NATURAL	J.L.	3.17.99

TOLERANCES UNLESS NOTED
 .XX=±.010
 .XXX=±.005
 FRAC=±1/64
 ANG=±1°